



UL INTERNATIONAL (UK) LTD  
 Womersley House, Building C,  
 The Guildway,  
 Old Portsmouth Road,  
 Guildford. GU3 1LR.  
 United Kingdom.



designated according to Article 29 of the Regulation (EU) No 305/2011 and member of EOTA (European Organisation for Technical Assessment, [www.eota.eu](http://www.eota.eu))

## European Technical Assessment

**ETA 14/0316**  
**of 22/08/2014**

**Technical Assessment Body issuing the ETA and designated according to Article 29 of the Regulation (EU) No 305/2011: UL International (UK) Ltd**

**Trade name of the construction product**

Joins Fire Wrap Pro+

**Product family to which the construction product belongs**

Fire Stopping and Sealing Product:  
 • Penetration Seals

**Manufacturer**

Joins L.R. Oy.  
 Teollisuustie 6  
 51200 Kangasniemi  
 Finland

**Manufacturing plant(s)**

A/003

**This European Technical Assessment contains**

35 pages including 1 Annex which forms an integral part of this assessment.

**This European Technical Assessment is issued in accordance with regulation (EU) No 305/2011, on the basis of**

ETAG 026-2, edition 2011, used as European Assessment Document (EAD).

Translations of this European Technical Assessment in other languages shall fully correspond to the original issued document and should be identified as such.

Communication of this European Technical Assessment, including transmission by electronic means, shall be in full. However, partial reproduction may be made, with the written consent of the issuing Technical Assessment Body. Any partial reproduction has to be identified as such.

## Table of Contents

<b>I.</b>	<b>SPECIFIC PARTS OF THE EUROPEAN TECHNICAL ASSESSMENT</b>	<b>3</b>
1	Technical description of the product	3
2	Specification of the intended uses of the product in accordance with the applicable European Assessment Document (Hereinafter EAD): ETAG 026-2	3
3	Performance of the product and references to the methods used for its assessment	5
4	ASSESSMENT AND VERIFICATION OF CONSTANCY OF PERFORMANCE (HEREINAFTER AVCP) SYSTEM APPLIED, WITH REFERENCE TO ITS LEGAL BASE	6
5	Technical details necessary for the implementation of the AVCP system, as provided for in the applicable EAD	6
6	Issued on:	7
	<b>ANNEX A – Resistance to Fire Classification – Joints Fire Wrap Pro+</b>	<b>8</b>
A.1	Rigid wall constructions with wall thickness of minimum 150 mm	8
A.1.1	Joints Fire Wrap Pro+ penetration seals, in 100 mm thick JOINTS FIRE COMPOUND PRO+ seals in rigid walls with insulated metal pipes	8
A.1.2	Joints Fire Wrap Pro+ penetration seals, in 100 mm thick JOINTS FIRE COMPOUND PRO+ seals in rigid walls with plastic pipes	11
A.2	Rigid floor constructions with a minimum thickness 150 mm	12
A.2.1	Joints Fire Wrap Pro+ penetration seals, in 100 mm thick JOINTS FIRE COMPOUND PRO+ seals in rigid floors, with insulated metal pipes	12
A.2.2	Joints Fire Wrap Pro+ penetration seals, in 100 mm thick JOINTS FIRE COMPOUND PRO+ seals in rigid floors, with insulated metal pipes	14
A.2.3	Joints Fire Wrap Pro+ penetration seals, in 100 mm thick JOINTS FIRE COMPOUND PRO+ seals in rigid floors, with insulated metal pipes	16
A.2.4	Joints Fire Wrap Pro+ penetration seals, in 100 mm thick JOINTS FIRE COMPOUND PRO+ seals in rigid floors, with plastic pipes	18
A.2.5	Joints Fire Wrap Pro+ penetration seals, in 50 mm thick JOINTS FIRE COMPOUND PRO+ seals, backed with 50 mm stone wool, in rigid floors, with plastic pipes	20
A.3	Flexible and rigid wall constructions with a minimum thickness 100 mm	21
A.3.1	Joints Fire Wrap Pro+ penetration seal for insulated metal pipes, in seals comprising 25 mm deep JOINTS FIRE COMPOUND PRO+ to both faces backed with 50 mm mineral fibre board, installed within flexible or rigid wall	21
A.3.2	Joints Fire Wrap Pro+ penetration seal for composite pipes, in seals comprising 25 mm deep JOINTS FIRE COMPOUND PRO+ to both faces backed with 50 mm mineral fibre board, installed within flexible or rigid wall	23
A.3.3	Joints Fire Wrap Pro+ penetration seal for insulated metal & composite pipes, in seals comprising 25 mm deep JOINTS FIRE COMPOUND PRO+ to both faces backed with 50 mm mineral fibre board, installed within flexible or rigid wall	24
A.3.4	Joints Fire Wrap Pro+ penetration seal for insulated metal pipes, in seals comprising 50 mm deep JOINTS FIRE COMPOUND PRO+ to both faces, installed within flexible or rigid wall	25
A.4	Rigid wall constructions with floor thickness of minimum 150 mm	27
A.4.1	Joints Fire Wrap Pro+ penetration seal for insulated metal pipes, in 1x Joints Fire Board Pro+ 2-S seals, in rigid walls	27
A.5	Rigid floor constructions with floor thickness of minimum 150 mm	28
A.5.1	Joints Fire Wrap Pro+ penetration seal for plastic pipes, in 1x Joints Fire Board Pro+ 2-S, in rigid floors	28
A.5.2	Joints Fire Wrap Pro+ penetration seal for insulated metal pipes, in 1x Joints Fire Board Pro+ 2-S, in rigid floors	29
A.5.3	Joints Fire Wrap Pro+ penetration seal for insulated metal pipes in 2x Joints Fire Board Pro+ 2-S (separated), in rigid floors	30
A.5.4	Joints Fire Wrap Pro+ penetration seal for insulated metal pipes, in 2x Joints Fire Board Pro+ 2-S (back to back), in rigid floors	31
A.6	Flexible or rigid wall constructions with wall thickness of minimum 100 mm	33
A.6.1	Joints Fire Wrap Pro+ penetration seal for insulated metal pipes, in 2x Joints Fire Board Pro+ 1-S, in flexible or rigid walls	33
A.6.2	Joints Fire Wrap Pro+ penetration seal for insulated metal pipes, in 2x Joints Fire Board Pro+ 1-S, in flexible or rigid walls	35
A.6.3	Joints Fire Wrap Pro+ penetration seal for insulated metal pipes, in 2x Joints Fire Board Pro+ 1-S, in flexible or rigid walls	36
A.6.4	Joints Fire Wrap Pro+ penetration seal for plastic pipes, in 2x Joints Fire Board Pro+ 1-S, in flexible or rigid walls	37
A.6.5	Penetration seal in JOINTS FIRE COMPOUND PRO+ seals, in flexible* and rigid walls minimum 100 mm thick	39

## I. SPECIFIC PARTS OF THE EUROPEAN TECHNICAL ASSESSMENT

### 1 Technical description of the product

- 1) Joints Fire Wrap Pro+ is a pipe closure device used to form penetration seals where combustible pipes and insulated metal pipes penetrate walls and floors.
- 2) The Joints Fire Wrap Pro+ is supplied in Polyethylene bags size according to pipe diameter. The wrap is wrapped around the pipe and pushed into the aperture in the separating element/Joints Fire Board Pro+ or cast in with JOINTS FIRE COMPOUND PRO+.
- 3) The applicant has submitted a written declaration that the product and/or constituents of the product contains no substances which have been classified as dangerous according to Directive 67/548/EEC and Regulation (EC) No. 1272/2008 and listed in the 'indicative list on dangerous substances' of the EGDS – taking into account the installation conditions of the construction product and the release scenarios resulting from there.

In addition to the specific clauses relating to dangerous substances contained in this European Technical Assessment, there may be other requirements applicable to the products falling within its scope (e.g. transposed European legislation and national laws, regulations and administrative provisions). In order to meet the provisions of the Construction Products Regulation, these requirements need also to be complied with, when and where they apply.

- 4) The use category of Joints Fire Wrap Pro+ in relation to BWR 3 (Hygiene, health and environment) is IA1, S/W3

### 2 Specification of the intended uses of the product in accordance with the applicable European Assessment Document (Hereinafter EAD): ETAG 026-2

Detailed information and data is given in Annex A.

The intended use of system Joints Fire Wrap Pro+ is to reinstate the fire resistance performance of flexible wall and rigid wall and floor constructions, where they are penetrated by services.

- 1) The specific elements of construction that the system Joints Fire Wrap Pro+ may be used to provide a penetration seal in, are as follows:

Flexible walls: The wall must have a minimum thickness of 100 mm and comprise steel studs lined on both faces with minimum 2 layers of 12.5 mm thick boards.

Rigid walls: The wall must have a minimum thickness of 100 mm and comprise concrete, aerated concrete or masonry, with a minimum density of 650 kg/m<sup>3</sup>.

Rigid floors: The floor must have a minimum thickness of 150 mm and comprise aerated concrete or concrete with a minimum density of 650 kg/m<sup>3</sup>.

The supporting construction must be classified in accordance with EN 13501-2 for the required fire resistance period.

- 2) The system Joints Fire Wrap Pro+ may be used to provide a penetration seal with specific supporting constructions and substrates (for details see Annex A).

- 3) The provisions made in this European Technical Assessment are based on an assumed working life of the Joints Fire Wrap Pro+ of 10 years, provided that the conditions laid down in the manufacturers datasheet and instructions for the packaging/transport/storage/installation/use/repair are met. The indications given on the working life cannot be interpreted as a guarantee given by the producer, but are to be regarded only as a means for choosing the right products in relation to the expected economically reasonable working life of the works.
- 4) Type X: intended for use at conditions exposed to weathering.

**3 Performance of the product and references to the methods used for its assessment**

Product-type: Pipe Wrap		Intended use: Penetration Seal
Basic requirement for construction work	Basic Requirement	Performance
<b>BWR 1 Mechanical resistance and stability</b>		
-	None	Not relevant
<b>BWR 2 Safety in case of fire</b>		
EN 13501-1	Reaction to fire	Class F (not tested)
EN 13501-2	Resistance to fire	Annex A
<b>BWR 3 Hygiene, health and environment</b>		
EN 1026:2000	Air permeability (material property)	No performance determined
ETAG 026-2, Annex C	Water permeability (material property)	No performance determined
Declaration of manufacturer	Release of dangerous substances	Use categories: IA1, S/W3 Declaration of manufacturer
<b>BWR 4 Safety in use</b>		
EOTA TR 001:2003	Mechanical resistance and stability	No performance determined
EOTA TR 001:2003	Resistance to impact/movement	No performance determined
EOTA TR 001:2003	Adhesion	No performance determined
<b>BWR 5 Protection against noise</b>		
EN 10140-2/ EN ISO 717-1	Airborne sound insulation	No performance determined
<b>BWR 6 Energy economy and heat retention</b>		
EN 12664, EN 12667 or EN 12939	Thermal properties	No performance determined
EN ISO 12572 EN 12086	Water vapour permeability	No performance determined
<b>General aspects relating to fitness for use</b>		
EOTA TR 024:2009, clause 3.1.11 & 3.1.12	Durability and serviceability	X
<b>BWR 7 Sustainable use of natural resources</b>		
-	-	No performance determined

**4 ASSESSMENT AND VERIFICATION OF CONSTANCY OF PERFORMANCE (HEREINAFTER AVCP) SYSTEM APPLIED, WITH REFERENCE TO ITS LEGAL BASE**

According to the decision 1999/454/EC – Commission Decision of date 22nd June 1999 on the procedure for attesting the conformity of construction products pursuant to Article 20(2) of Council Directive 89/106/EEC as regards fire stopping, fire sealing and fire protective products, published in the Official Journal of the European Union (OJEU) L178/52 of 14/07/1999, see <http://eur-lex.europa.eu/JOIndex.do> of the European Commission<sup>1</sup>, as amended, the system(s) of assessment and verification of constancy of performance (see Annex V to Regulation (EU) No 305/2011) given in the following table(s) applies (apply).

<b>Product(s)</b>	<b>Intended use(s)</b>	<b>Level(s) or class(es)</b>	<b>System(s)</b>
Fire stopping and Fire Sealing Products	For fire compartmentation and/or fire protection or fire performance	Any	1

**5 Technical details necessary for the implementation of the AVCP system, as provided for in the applicable EAD**

Tasks of the manufacturer:

Factory production control

The manufacturer shall exercise permanent internal control of production. All the elements, requirements and provisions adopted by the manufacturer shall be documented in a systematic manner in the form of written policies and procedures, including records of results performed. This production control system shall ensure that the product is in conformity with this European Technical Assessment.

The manufacturer may only use initial / raw / constituent materials stated in the technical documentation of this European Technical Assessment.

The factory production control shall be in accordance with the Control Plan of 27<sup>th</sup> June 2014 relating to the European Technical Assessment ETA 14/0316 issued on 22/08/14 which is part of the technical documentation of this European Technical Assessment. The "Control Plan" is laid down in the context of the factory production control system operated by the manufacturer and deposited at UL International (UK) Ltd.

The results of factory production control shall be recorded and evaluated in accordance with the provisions of the Control Plan.

---

<sup>1</sup> Official Journal of the European Communities L178/52 of 14/7/1999

Other tasks of the manufacturer

Additional information

The manufacturer shall provide a technical data sheet and an installation instruction with the following minimum information:

(a) Technical data sheet:

- Field of application:
- Building elements for which the penetration seal is suitable, type and properties of the building elements like minimum thickness, density, and - in case of lightweight constructions – the construction requirements.
- Limits in size, minimum thickness etc. of the penetration seal
- Construction of the penetration seal including the necessary components and additional products (e.g. backfilling material) with clear indication whether they are generic or specific.

(b) Installation instruction:

- Steps to be followed
- Procedure in case of retrofitting
- Stipulations on maintenance, repair and replacement

**6 Issued on:**

**22<sup>nd</sup> August 2014**

Report by:



C. Johnson  
Staff Engineer  
Building and Life Safety Technologies

Reviewed by:



C. W. Miles  
Business Manager – Europe & Latin America  
Building and Life Safety Technologies

**For and on behalf of UL International (UK) Ltd.**

## ANNEX A – Resistance to Fire Classification – Joints Fire Wrap Pro+

### A.1 Rigid wall constructions with wall thickness of minimum 150 mm

#### A.1.1 Joints Fire Wrap Pro+ penetration seals, in 100 mm thick JOINTS FIRE COMPOUND PRO+ seals in rigid walls with insulated metal pipes

**Penetration Seal:** CS (Continuous Sustained) insulated metallic pipes fitted at any position within the aperture (min. separation 10 mm from seal edges), with 100 mm JOINTS FIRE COMPOUND PRO+ to either side of the wall. Joints Fire Wrap Pro+ are required to be centrally within the seal for pipes with combustible insulation. Maximum seal size 2400 mm wide x 1200 mm high

Construction details:

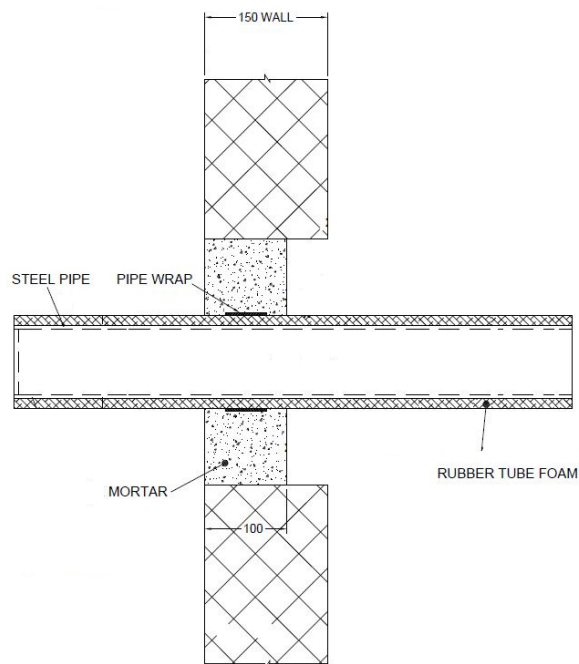



**A.1.1.1**

Services	Wrap	Insulation	Classification
Mild or stainless steel pipe			
40 mm diameter/1.5-14.2 mm wall	1 off 50 x 3.6mm Joints Fire Wrap Pro+, fitted central	13 mm Kaiflex ST insulation	<b>EI 240 C/U</b>
165 mm diameter/4.5-14.2 mm wall		9 mm Kaiflex ST insulation	<b>E 240 C/U, EI 30 C/U</b>
40 mm diameter/1.5-14.2 mm wall*	1 off 50 x 1.8mm Joints Fire Wrap Pro+, fitted central	13 -19 mm Kaiflex ST insulation	<b>E 240 C/U, EI 60 C/U</b>
50 mm diameter/1.6-14.2 mm wall*			
60 mm diameter/1.7-14.2 mm wall*			
75 mm diameter/1.9-14.2 mm wall*			
90 mm diameter/2-14.2 mm wall*			
100 mm diameter/2.1-14.2 mm wall*			
115 mm diameter/2.3-14.2 mm wall*			
140 mm diameter/2.6-14.2 mm wall*			
165 mm diameter/2.8-14.2 mm wall*			

\* Typical pipe diameters shown, see below graph for intermediate sizes

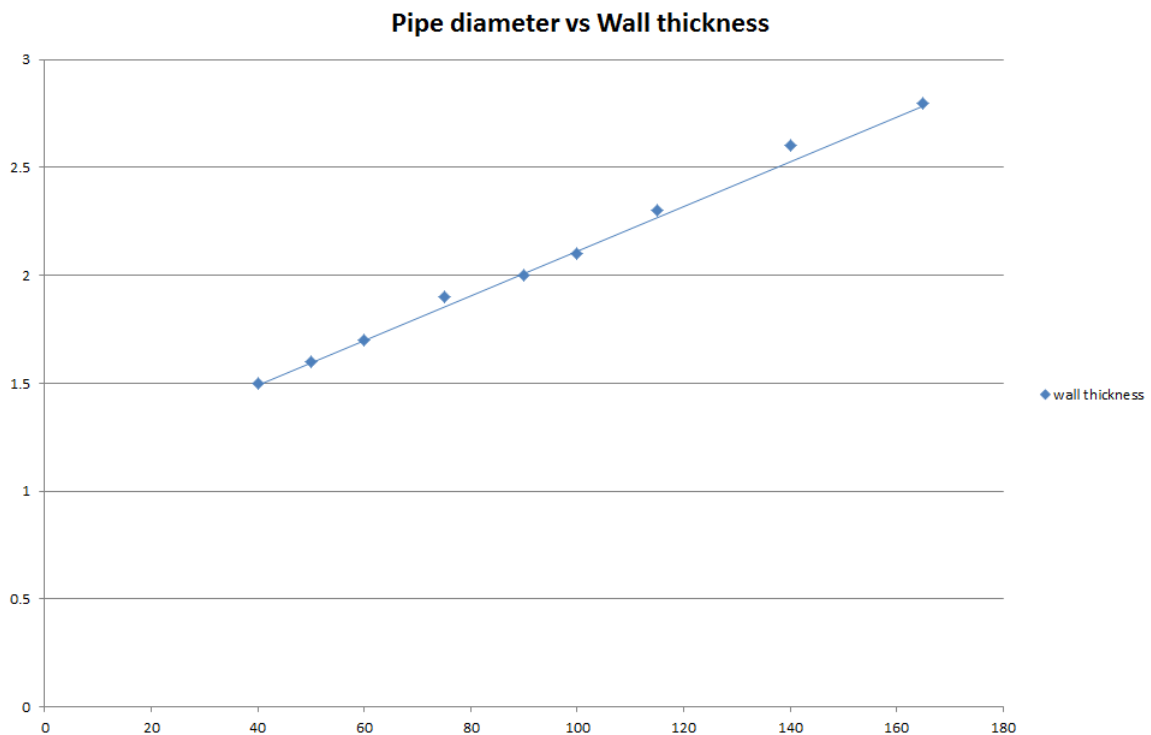

**A.1.1.2**

Services	Wrap	Insulation	Classification
Mild or stainless steel pipe	1 off 50 x 3.6mm Joints Fire Wrap Pro+, fitted central	13-25 mm Kaiflex ST insulation	<b>E 180 C/U, EI 60 C/U</b>
40 mm diameter/1.5-14.2 mm wall*			
50 mm diameter/1.8-14.2 mm wall*			
60 mm diameter/2-14.2 mm wall*			
75 mm diameter/2.3-14.2 mm wall*			
90 mm diameter/2.7-14.2 mm wall*			
100 mm diameter/2.9-14.2 mm wall*			
115 mm diameter/3.3-14.2 mm wall*			
140 mm diameter/3.9-14.2 mm wall*			
165 mm diameter/4.5-14.2 mm wall*			

\* Typical pipe diameters shown, see below graph for intermediate sizes

**Pipe diameter vs Wall thickness**

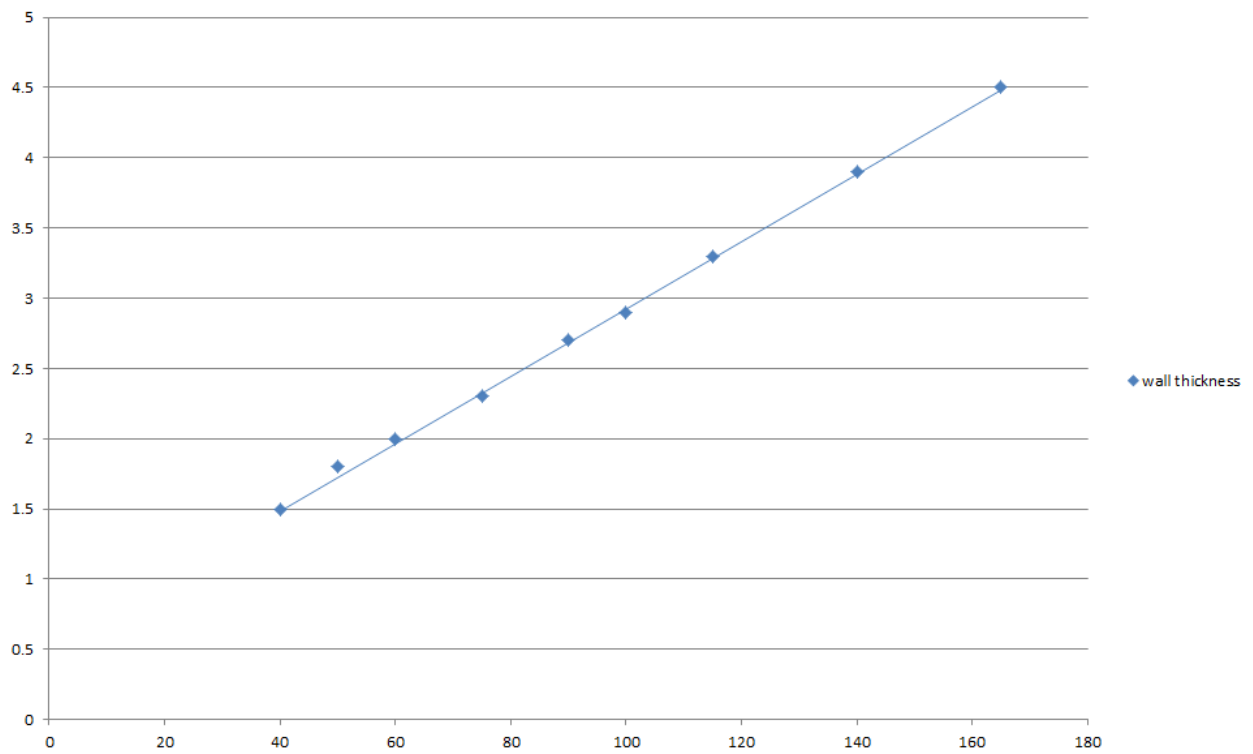

**A.1.2 Joints Fire Wrap Pro+ penetration seals, in 100 mm thick JOINTS FIRE COMPOUND PRO+ seals in rigid walls with plastic pipes**

**Penetration Seal:** plastic pipes fitted at any position within the aperture (min. separation 10 mm from seal edges), with 100 mm JOINTS FIRE COMPOUND PRO+ to either side of the wall. Joints Fire Wrap Pro+ are required to be centrally within the seal. Maximum seal size 2400 mm wide x 1200 mm high

Construction details:

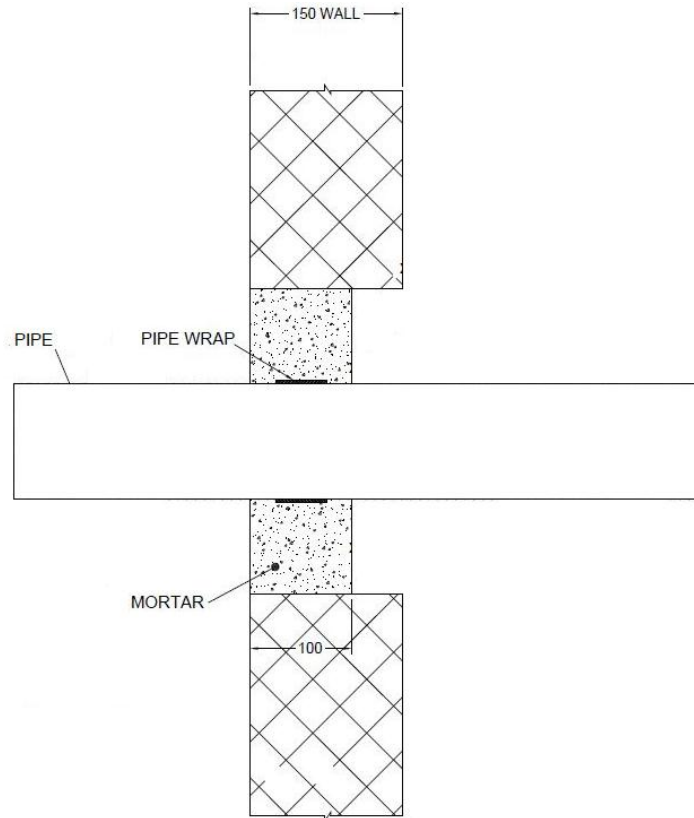

**A.1.2.1**

Services	Wrap	Insulation	Classification
PVC-U pipe according to EN 1329-1, EN 1452-1 and EN 1453-1* and PVC-C according to EN 1566-1			
315 mm diameter/9.2 mm wall	1 off 75 x 18 mm Joints Fire Wrap Pro+, fitted central	None	EI 120 C/C

\* In Germany the pipes have additionally to comply with DIN 19531-10

## A.2 Rigid floor constructions with a minimum thickness 150 mm

### A.2.1 Joints Fire Wrap Pro+ penetration seals, in 100 mm thick JOINTS FIRE COMPOUND PRO+ seals in rigid floors, with insulated metal pipes

**Penetration Seal:** CS (Continuous Sustained) insulated metallic pipes fitted at any position within the aperture (min. separation 25 mm from seal edges and 100 mm from other services), with 100 mm JOINTS FIRE COMPOUND PRO+ at any position within the floor. Joints Fire Wrap Pro+ are required to be fitted around combustible pipe insulation. Maximum seal size 400 mm wide x 400 mm long.

Construction details:

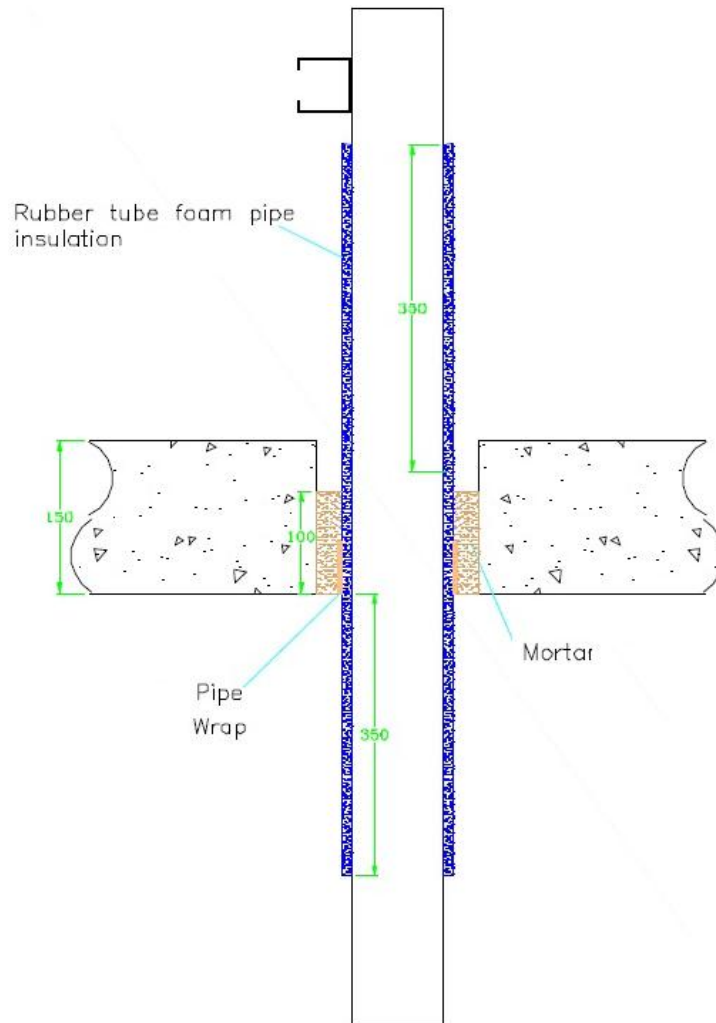

**A.2.1.1**

Services	Wrap	Insulation	Classification
Copper pipe	50 x 3.6 mm Joints Fire Wrap Pro+ fitted to the soffit	9 mm Kaiflex ST insulation	EI 240 C/C
12 mm diameter/1 mm wall		13-25 mm Kaiflex ST insulation	E 240 C/C, EI 60 C/C
12-54 mm diameter/1-1.2 mm wall			
Geberit Mepla MLC (PE-Xb/Aluminium/PE-HD pipe)			
16 mm diameter/2.25 mm wall	50 x 3.6 mm Joints Fire Wrap Pro+ fitted to the soffit	9 mm Kaiflex ST insulation	EI 240 C/C
16 mm diameter/2.25 mm wall		9-13 mm Kaiflex ST insulation	E 240 C/C, EI 90 C/C
20 mm diameter/2.5 mm wall			
26 mm diameter/3 mm wall			
32 mm diameter/3 mm wall			
40 mm diameter/3.5 mm wall			
50 mm diameter/4 mm wall			
63 mm diameter/4.5 mm wall		13-25 mm Kaiflex ST insulation	E 180 C/C, EI 90 C/C
75 mm diameter/4.7 mm wall			
16 mm diameter/2.25 mm wall			
20 mm diameter/2.5 mm wall			
26 mm diameter/3 mm wall			
32 mm diameter/3 mm wall			
40 mm diameter/3.5 mm wall			
50 mm diameter/4 mm wall			
63 mm diameter/4.5 mm wall			
75 mm diameter/4.7 mm wall			

**A.2.2 Joints Fire Wrap Pro+ penetration seals, in 100 mm thick JOINTS FIRE COMPOUND PRO+ seals in rigid floors, with insulated metal pipes**

**Penetration Seal:** CS (Continuous Sustained) insulated metallic pipes fitted at any position within the aperture (min. separation 25 mm from seal edges and 100 mm from other services), with 100 mm JOINTS FIRE COMPOUND PRO+ at any position within the floor. Joints Fire Wrap Pro+ are required to be fitted around combustible pipe insulation. Maximum seal size 2400 mm wide x 1200 mm long

Construction details:

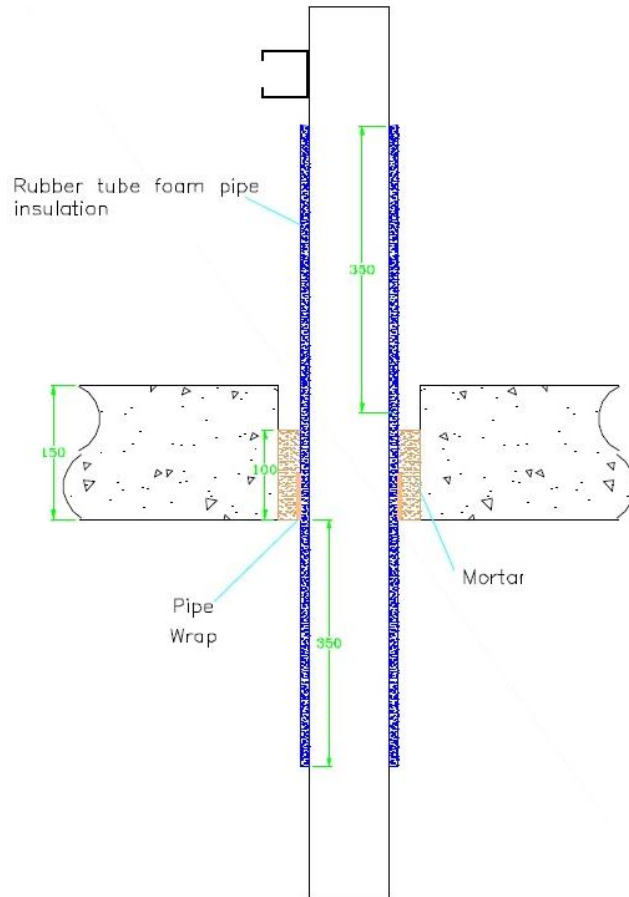

### A.2.2.1

Services	Wrap	Insulation	Classification
Copper pipe			
12 mm diameter/1 mm wall	50 x 3.6 mm Joints Fire Wrap Pro+ fitted to the soffit	9 mm Kaiflex ST insulation	EI 180 C/C
12-54 mm diameter/1-1.2 mm wall		13-25 mm Kaiflex ST insulation	E 180 C/C, EI 60 C/C
Geberit Mepla MLC (PE-Xb/Aluminium/PE-HD pipe)			
16 mm diameter/2.25 mm wall	50 x 3.6 mm Joints Fire Wrap Pro+ fitted to the soffit	9 mm Kaiflex ST insulation	EI 180 C/C
16 mm diameter/2.25 mm wall		13-25 mm Kaiflex ST insulation	E 180 C/C, EI 90 C/C
20 mm diameter/2.5 mm wall			
26 mm diameter/3 mm wall			
32 mm diameter/3 mm wall			
40 mm diameter/3.5 mm wall			
50 mm diameter/4 mm wall			
63 mm diameter/4.5 mm wall			
75 mm diameter/4.7 mm wall			

**A.2.3 Joints Fire Wrap Pro+ penetration seals, in 100 mm thick JOINTS FIRE COMPOUND PRO+ seals in rigid floors, with insulated metal pipes**

**Penetration Seal:** CS (Continuous Sustained) insulated metallic pipes fitted at any position within the aperture (min. separation 25 mm from seal edges and 100 mm from other services), with 100 mm JOINTS FIRE COMPOUND PRO+ at any position within the floor. Joints Fire Wrap Pro+ are required to be fitted around combustible pipe insulation. Maximum seal size 2400 mm wide x 1200 mm long

Construction details:

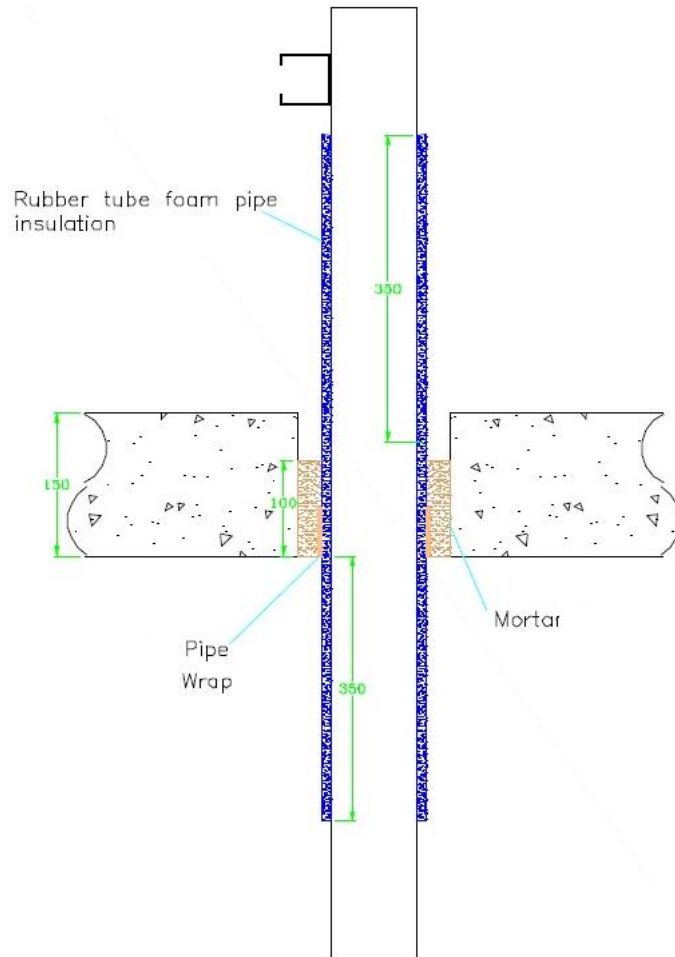



### A.2.3.1

Services	Wrap	Insulation	Classification
Mild or stainless steel pipe			
40 mm diameter/-14.2 mm wall	1 off 50 x 1.8 mm Joints Fire Wrap Pro+, fitted at soffit	13 mm Kaiflex ST insulation	<b>EI 180 C/U</b>
40 mm diameter/1.5-14.2 mm wall*		<b>E 180 C/U, EI 120 C/U</b>	13 -19 mm Kaiflex ST insulation
50 mm diameter/1.6-14.2 mm wall*			
60 mm diameter/1.7-14.2 mm wall*			
75 mm diameter/1.9-14.2 mm wall*			
90 mm diameter/2-14.2 mm wall*			
100 mm diameter/2.1-14.2 mm wall*			
115 mm diameter/2.3-14.2 mm wall*			
140 mm diameter/2.6-14.2 mm wall*			
165 mm diameter/2.8-14.2 mm wall*			

\* Typical pipe diameters shown, see below graph for intermediate sizes

**Pipe diameter vs Wall thickness**

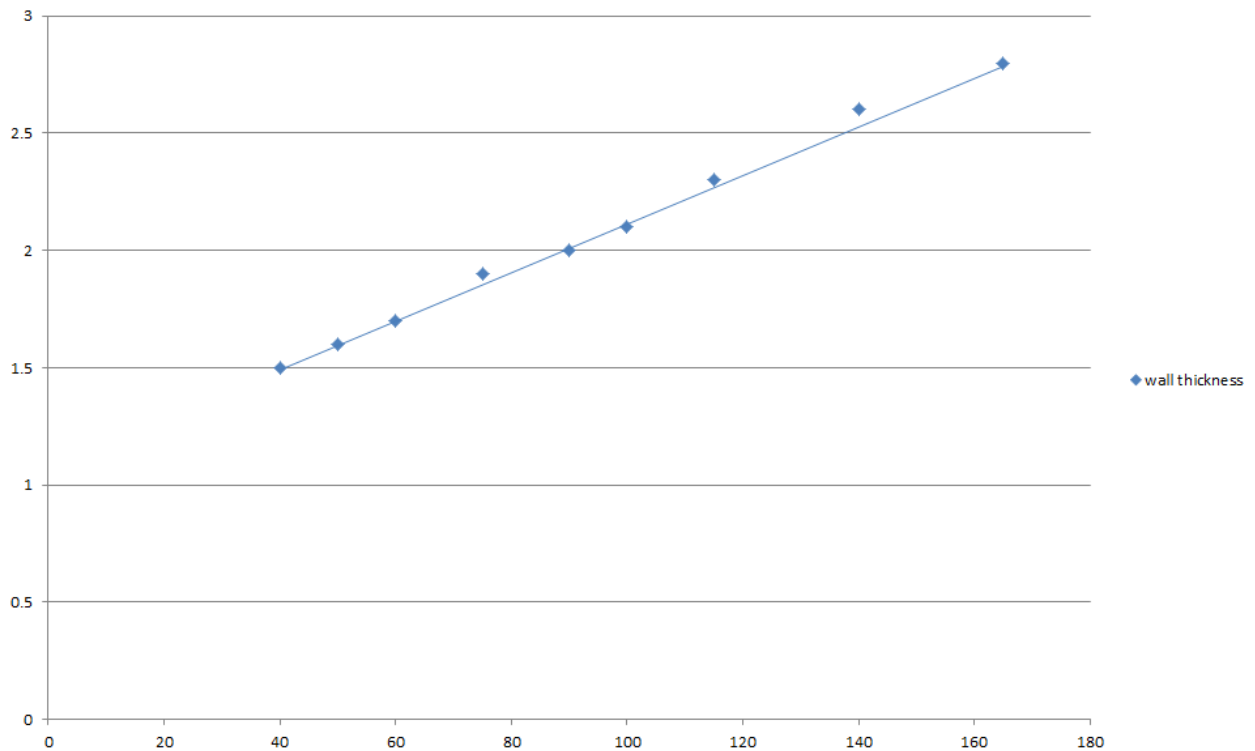

**A.2.4 Joints Fire Wrap Pro+ penetration seals, in 100 mm thick JOINTS FIRE COMPOUND PRO+ seals in rigid floors, with plastic pipes**

**Penetration Seal:** Plastic pipes fitted at any position within the aperture (min. separation 80 mm from seal edges and 100 mm from other services), with 100 mm JOINTS FIRE COMPOUND PRO+ to the top surface of the floor. Joints Fire Wrap Pro+s are required to be fitted to the bottom of the seal, as indicated below.

Construction details:

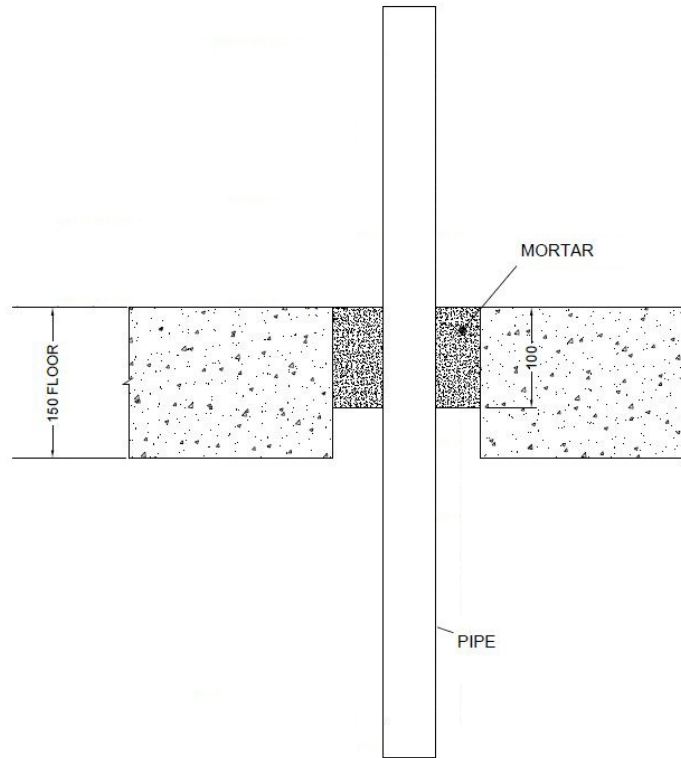

#### A.2.4.1

Services	Wrap	Maximum aperture	Classification
<b>PVC-U pipe according to EN 1329-1, EN 1452-1 and EN 1453-1* and PVC-C according to EN 1566-1</b>			
110 mm diameter / 3 mm wall	50 x 3.6 mm	200 x 200 mm	EI 240 C/C
110 mm diameter / 3 mm wall	50 x 3.6 mm	2400 x 1200 mm	EI 180 C/C
160 mm diameter / 4.0 mm wall	75 x 6 mm	2400 x 1200 mm	EI 180 C/C
160 mm diameter / 4.0 mm wall	75 x 8 mm	300 x 300 mm	EI 240 C/C
160 mm diameter / 4.0 mm wall	75 x 8 mm	2400 x 1200 mm	EI 180 C/C
110 mm diameter / 3.4 mm wall	75 x 2 mm	2400 x 1200 mm	EI 180 C/C
110 mm diameter / 3 mm wall	50 x 5.4 mm	300 x 300 mm	EI 240 C/C
110 mm diameter / 3 mm wall	50 x 5.4 mm	2400 x 1200 mm	EI 180 C/C
125 mm diameter / 3.5 mm wall	50 x 7.2 mm	300 x 300 mm	EI 240 C/C
125 mm diameter / 3.5 mm wall	50 x 7.2 mm	2400 x 1200 mm	EI 180 C/C
160 mm diameter / 4.5 mm wall	50 x 10.8 mm	300 x 300 mm	EI 240 C/C
160 mm diameter / 4.5 mm wall	50 x 10.8 mm	2400 x 1200 mm	EI 180 C/C
<b>PP pipe according to EN 1451-1</b>			
40 mm diameter / 3 mm wall	None	2400 x 1200 mm	EI 120 C/C
50 mm diameter / 2.5 mm wall	50 x 3.6 mm	300 x 300 mm	EI 240 C/C
50 mm diameter / 2.5 mm wall	50 x 3.6 mm	2400 x 1200 mm	EI 180 C/C
75 mm diameter / 3.5 mm wall	50 x 3.6 mm	300 x 300 mm	EI 240 C/C
75 mm diameter / 3.5 mm wall	50 x 3.6 mm	2400 x 1200 mm	EI 180 C/C
<b>PE pipe according to EN 1519-1, EN 12201-2 and EN 12666-1^, ABS according to EN 1455-1 and pipes made from SAN+PVC according to EN 1565-1</b>			
125 mm diameter / 4.9 mm wall	75 x 4 mm	300 x 300 mm	EI 180 C/C, E 240 C/C
125 mm diameter / 4.9 mm wall	75 x 6 mm	2400 x 1200 mm	EI 180 C/C
250 mm diameter / 7.8 mm wall	75 x 14 mm	2400 x 1200 mm	EI 180 C/C
160 mm diameter / 6.2 mm wall	75 x 8 mm	2400 x 1200 mm	EI 180 C/C

\* In Germany the pipes have additionally to comply with DIN 19531-10

^ In Germany the pipes have additionally to comply with DIN 19535-10

**A.2.5 Joints Fire Wrap Pro+ penetration seals, in 50 mm thick JOINTS FIRE COMPOUND PRO+ seals, backed with 50 mm stone wool, in rigid floors, with plastic pipes**

**Penetration Seal:** Plastic pipes (single) fitted at any position within the aperture (min. separation 80 mm from seal edges and 100 mm from other services), with 50 mm JOINTS FIRE COMPOUND PRO+ flush with the top of floor, backed with 50 mm stone wool 150 kg/m<sup>3</sup>. Joints Fire Wrap Pro+s are required to be fitted into the mortar seal.

Construction details:

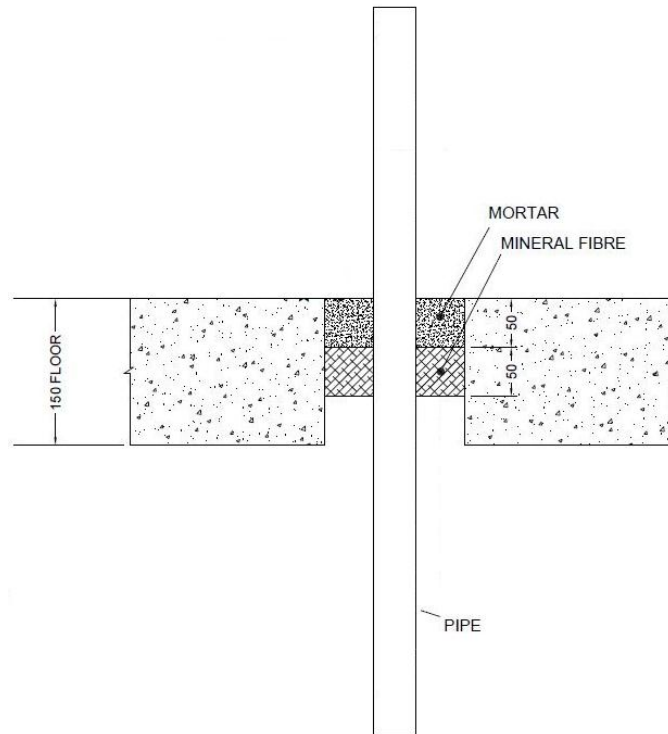

**A.2.5.1**

Services	Wrap	Maximum aperture	Classification
<b>PE pipe according to EN 1519-1, EN 12201-2 and EN 12666-1<sup>^</sup>, ABS according to EN 1455-1 and pipes made from SAN+PVC according to EN 1565-1</b>			
110 mm diameter / 4.3 mm wall	50 x 2 mm	2400 x 1200 mm	<b>EI 60 C/C</b>

<sup>^</sup> In Germany the pipes have additionally to comply with DIN 19535-10

### A.3 Flexible and rigid wall constructions with a minimum thickness 100 mm

#### A.3.1 Joints Fire Wrap Pro+ penetration seal for insulated metal pipes, in seals comprising 25 mm deep JOINTS FIRE COMPOUND PRO+ to both faces backed with 50 mm mineral fibre board, installed within flexible or rigid wall

**Penetration Seal:** CS (Continuous Sustained) insulated metallic pipes fitted at any position within the aperture (min. separation 30 mm from seal edges), with 25 mm JOINTS FIRE COMPOUND PRO+ to both sides of the wall, backed with 50 mm stone wool board 150 kg/m<sup>3</sup> or 50 mm JOINTS FIRE COMPOUND PRO+ to both sides of the wall without backing\*. Joints Fire Wrap Pro+s are required to be fitted to both faces of the seal.

Construction details:

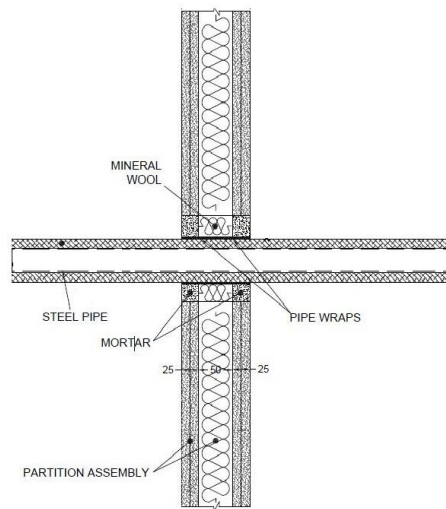

\* Maximum seal size of 2400 mm wide x 1200 mm high

### A.3.1.1

Services	Wrap	Insulation	Classification
Mild or stainless steel pipe			
40 mm diameter/1-14.2 mm wall	2 off 50 x 1.8 mm Joints Fire Wrap Pro+, one fitted flush to each face of seal	13 mm Kaiflex ST insulation	EI 120 C/U
40 mm diameter/1-14.2 mm wall*	2 off 50 x 3.6 mm Joints Fire Wrap Pro+, one fitted flush to each face of seal		E 120 C/U, EI 60 C/U
50 mm diameter/1.3-14.2 mm wall*			
60 mm diameter/1.6-14.2 mm wall*			
75 mm diameter/2-14.2 mm wall*			
90 mm diameter/2.4-14.2 mm wall*			
100 mm diameter/2.7-14.2 mm wall*			
115 mm diameter/3.1-14.2 mm wall*			
140 mm diameter/3.8-14.2 mm wall*			
165 mm diameter/ 4.5-14.2 mm wall*			

\* Typical pipe diameters shown, see below graph for intermediate sizes

Pipe diameter vs Wall thickness

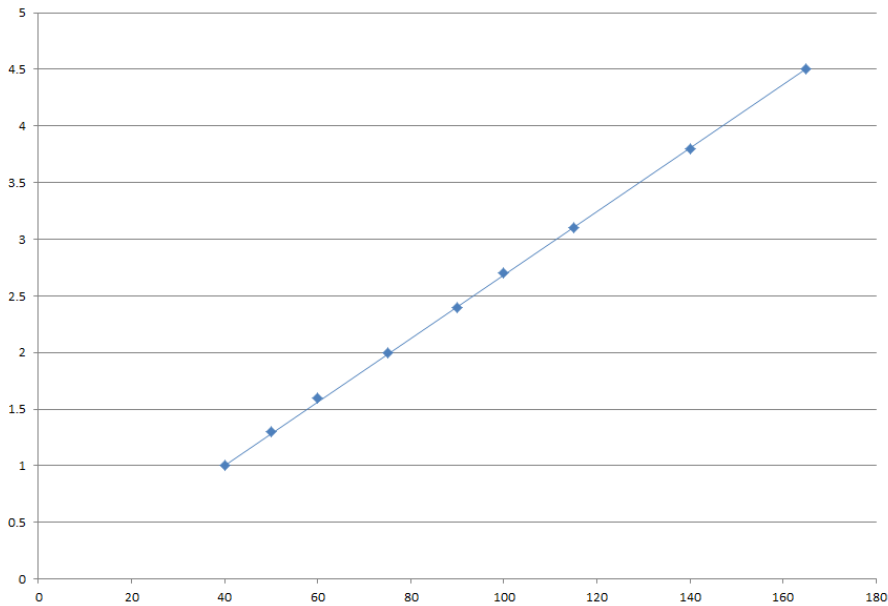

**A.3.2 Joints Fire Wrap Pro+ penetration seal for composite pipes, in seals comprising 25 mm deep JOINTS FIRE COMPOUND PRO+ to both faces backed with 50 mm mineral fibre board, installed within flexible or rigid wall**

Penetration Seal: 500 mm (min.)\* LI (Local Interrupted) or CI (Continuous Interrupted) insulated metallic (and composite) pipes (single) fitted at any position within the aperture (min. separation 40 mm from seal edges and 100 mm from other services), with 25 mm JOINTS FIRE COMPOUND PRO+ to both sides of the wall backed with 50 mm stone wool board 150 kg/m<sup>3</sup>. Maximum seal size 2400 mm wide x 1200 mm high

Construction details:

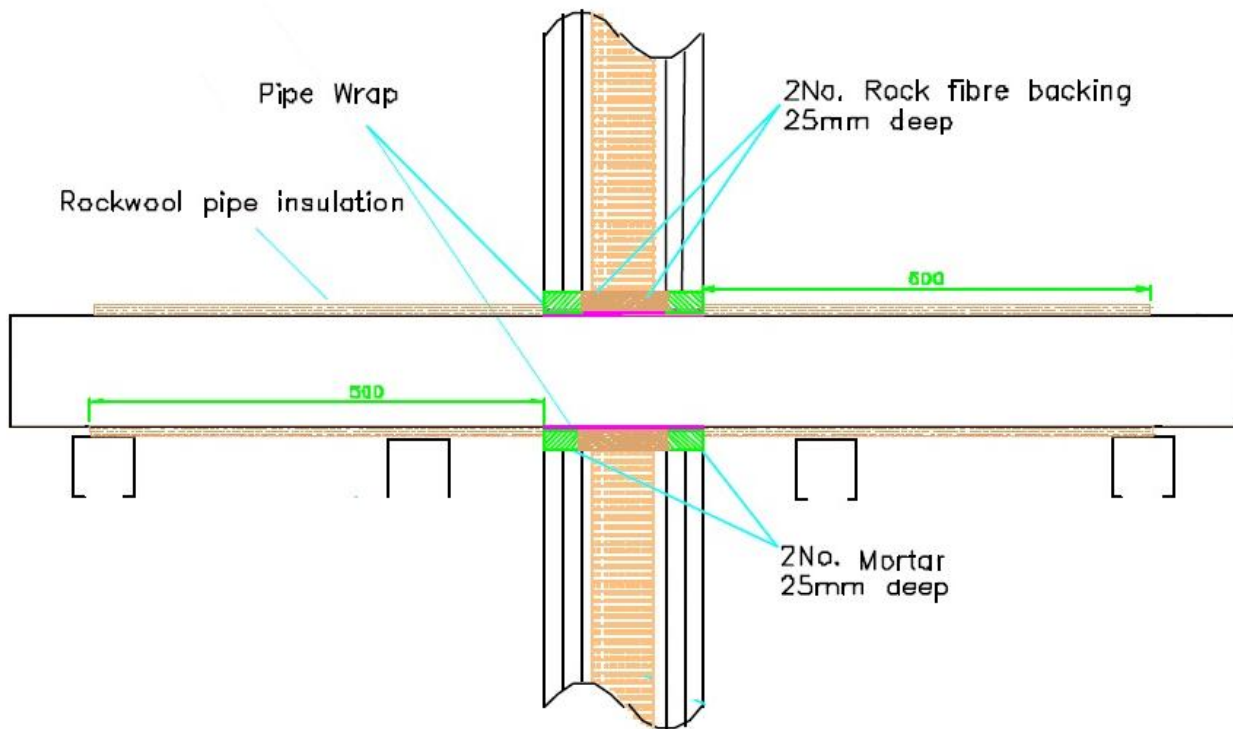

**A.3.2.1**

Services	Insulation	Classification
Geberit Mepla MLC (PE-Xb/Aluminium/PE-HD) pipe	Minimum 20 mm stone wool, minimum 80 kg/m <sup>3</sup>	EI 120 C/C
16 mm diameter/2.25 mm wall		
20 mm diameter/2.5 mm wall		
26 mm diameter/3 mm wall		
32 mm diameter/3 mm wall		
40 mm diameter/3.5 mm wall		
50 mm diameter/4 mm wall		
63 mm diameter/4.5 mm wall		
75 mm diameter/4.7 mm wall		

**A.3.3 Joints Fire Wrap Pro+ penetration seal for insulated metal & composite pipes, in seals comprising 25 mm deep JOINTS FIRE COMPOUND PRO+ to both faces backed with 50 mm mineral fibre board, installed within flexible or rigid wall**

Penetration Seal: CS (Continuous Sustained) insulated metallic and composite pipes fitted at any position within the aperture (min. separation 25 mm from seal edges), with 25 mm JOINTS FIRE COMPOUND PRO+ to both sides of the wall, backed with 25 mm stone wool 150 kg/m3\*. Joints Fire Wrap Pro+s are required to be fitted to both faces of the seal. Maximum seal size 2400 mm wide x 1200 mm long

Construction details:

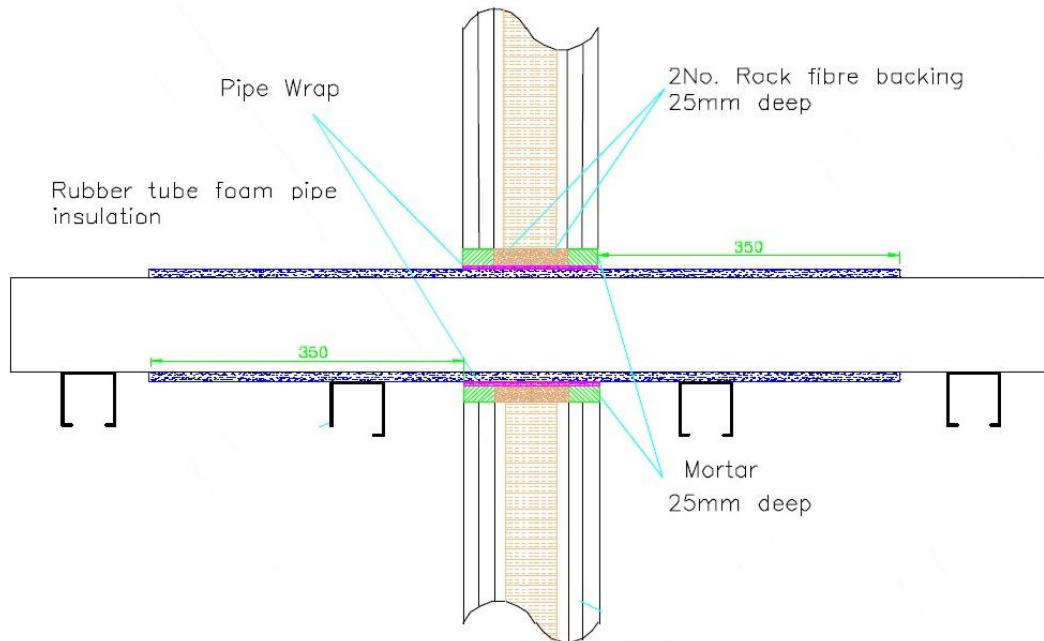

**A.3.3.1**

Services	Wrap	Insulation	Classification
Copper pipe			
12-54 mm diameter/1-1.2 mm wall	50 x 3.6 mm Joints Fire Wrap Pro+ fitted to both sides of the seal	9-25 mm Kaiflex ST insulation	EI 120 C/C
Geberit Mepla MLC (PE-Xb/Aluminium/PE-HD pipe)			
16 mm diameter/2.25 mm wall	50 x 3.6 mm Joints Fire Wrap Pro+ fitted to both sides of the seal	9-25 mm Kaiflex ST insulation	EI 120 C/C
20 mm diameter/2.5 mm wall			
26 mm diameter/3 mm wall			
32 mm diameter/3 mm wall			
40 mm diameter/3.5 mm wall			
50 mm diameter/4 mm wall			
63 mm diameter/4.5 mm wall			
75 mm diameter/4.7 mm wall			



**A.3.4 Joints Fire Wrap Pro+ penetration seal for insulated metal pipes, in seals comprising 50 mm deep JOINTS FIRE COMPOUND PRO+ to both faces, installed within flexible or rigid wall**

**Penetration Seal:** CS (Continuous Sustained) insulated metallic pipes fitted at any position within the aperture (min. separation 30 mm from seal edges), 50 mm JOINTS FIRE COMPOUND PRO+ to both sides of the wall without backing\*. Joints Fire Wrap Pro+s are required to be fitted to both faces of the seal.

Construction details:

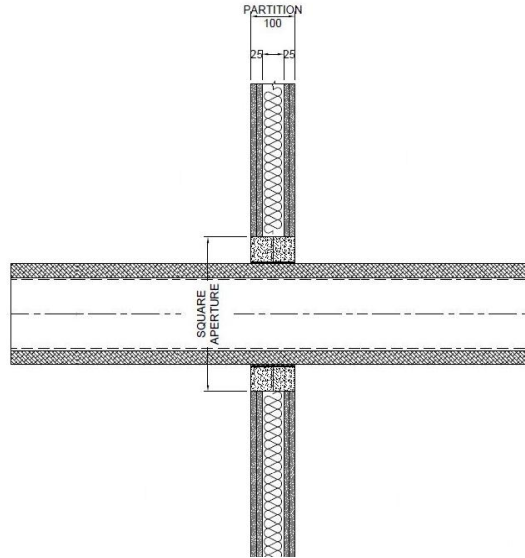

\* Maximum seal size of 2400 mm wide x 1200 mm high

**A.3.4.1**

Services	Wrap	Insulation	Classification
Mild or stainless steel pipe			
40 mm diameter/1-14.2 mm wall*	2 off 50 x 3.6 mm Joints Fire Wrap Pro+, one fitted flush to each face of seal	13 -32 mm Kaiflex ST insulation	<b>E 120 C/U, EI 60 C/U</b>
50 mm diameter/1.3-14.2 mm wall*			
60 mm diameter/1.6-14.2 mm wall*			
75 mm diameter/2-14.2 mm wall*			
90 mm diameter/2.4-14.2 mm wall*			
100 mm diameter/2.7-14.2 mm wall*			
115 mm diameter/3.1-14.2 mm wall*			
140 mm diameter/3.8-14.2 mm wall*			
165 mm diameter/ 4.5-14.2 mm wall*			

\* Typical pipe diameters shown, see below graph for intermediate sizes

**Pipe diameter vs Wall thickness**

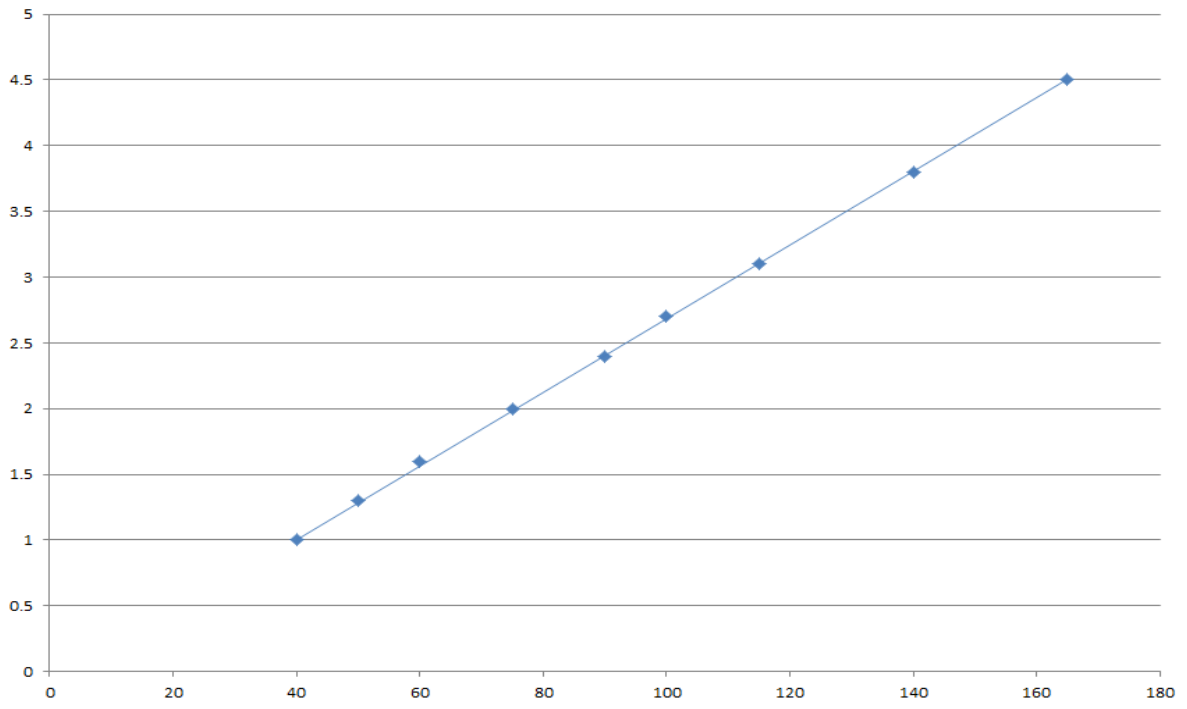

**A.4 Rigid wall constructions with floor thickness of minimum 150 mm**

**A.4.1 Joints Fire Wrap Pro+ penetration seal for insulated metal pipes, in 1x Joints Fire Board Pro+ 2-S seals, in rigid walls**

**Penetration Seal:** CS (Continuous Sustained) insulated metallic pipes fitted at any position within the aperture (min. separation 40 mm from seal edges and 100 mm from other services), with 60 mm Joints Fire Board Pro+ 2-S to either side of the wall (or anywhere in between). Joints Fire Wrap Pro+ are required to be fitted around combustible pipe insulation. Maximum aperture size 2400 mm x 1200 mm

Construction details:

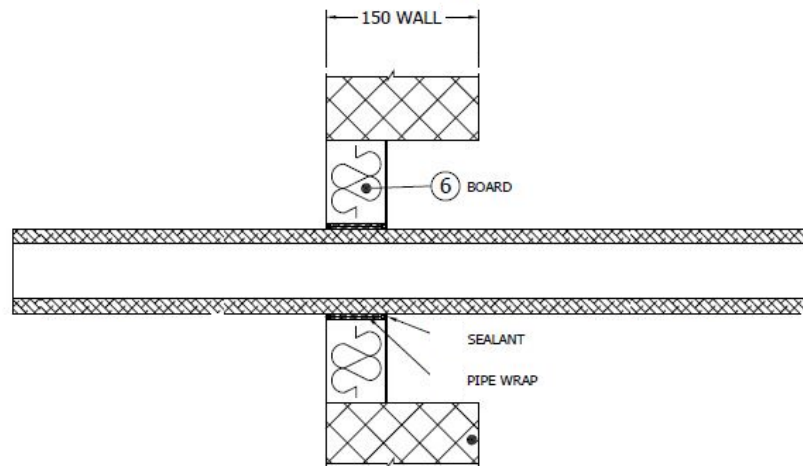

**A.4.1.1**

Services	Wrap	Insulation	Classification
Mild or stainless steel pipe			
165 mm diameter/ 4.5-14.2 mm wall	50 x 1.8 mm Joints Fire Wrap Pro+ fitted centrally	9-25 mm Kaiflex ST/KK insulation	<b>E 120 U/C, E 120 C/U, E 120 C/C, EI 45 U/C, EI 45 C/U, EI 45 C/C</b>

**A.5 Rigid floor constructions with floor thickness of minimum 150 mm**

**A.5.1 Joints Fire Wrap Pro+ penetration seal for plastic pipes, in 1x Joints Fire Board Pro+ 2-S, in rigid floors**

**Penetration Seal:** Combustible pipes fitted at any position within the aperture (min. separation 40 mm from seal edges and 100 mm from other services), with 50 mm Joints Fire Board Pro+ 2-S at mid-depth of the floor. Joints Fire Wrap Pro+ are required to be fitted around combustible pipe insulation. Maximum aperture size 400 mm x 400 mm

Construction details:

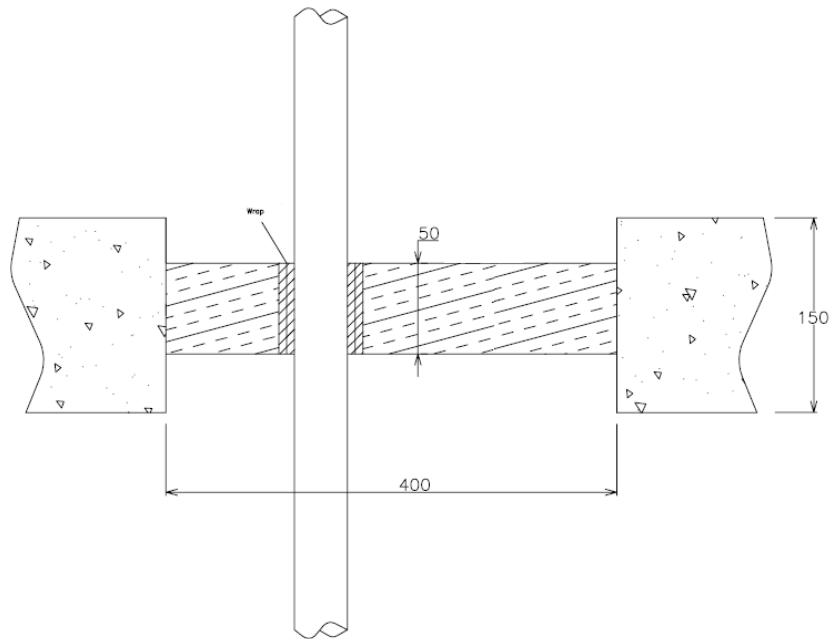

**A.5.1.1**

Services	Wrap	Classification
PVC-U pipe according to EN 1329-1, EN 1452-1 and EN 1453-1* 110 mm diameter/ 3.4mm wall	50 x 3.6 mm Joints Fire Wrap Pro+	EI 90 U/C, EI 90 C/C

**A.5.2 Joints Fire Wrap Pro+ penetration seal for insulated metal pipes, in 1x Joints Fire Board Pro+ 2-S, in rigid floors**

**Penetration Seal:** CS (Continuous Sustained) insulated metallic pipes fitted at any position within the aperture (min. separation 40 mm from seal edges and 100 mm from other services), with 60 mm Joints Fire Board Pro+ 2-S to either side of the floor (or anywhere in between). Joints Fire Wrap Pro+ are required to be fitted around combustible pipe insulation. Maximum aperture size 2400 mm x 1200 mm

Construction details:

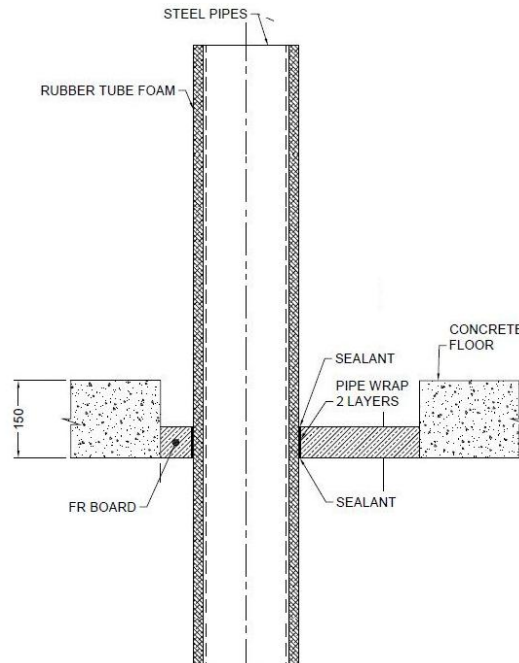

**A.5.2.1**

Services	Wrap	Insulation	Classification
Mild or stainless steel pipe	50 x 3.6 mm Joints Fire Wrap Pro+ fitted at bottom of seal	13 mm Kaiflex ST insulation	<b>E 90 C/U, EI 45 C/U</b>
165 mm diameter/ 4.5-14.2 mm wall		19 mm Kaiflex ST insulation	<b>EI 90 C/U</b>

**A.5.3 Joints Fire Wrap Pro+ penetration seal for insulated metal pipes in 2x Joints Fire Board Pro+ 2-S (separated), in rigid floors**

**Penetration Seal:** CS (Continuous Sustained) insulated metallic pipes fitted at any position within the aperture (min. separation 40 mm from seal edges and 100 mm from other services), with 60 mm Joints Fire Board Pro+ 2-S to both sides of the floor. Joints Fire Wrap Pro+ are required to be fitted around combustible pipe insulation at the soffit. Maximum aperture size 2400 mm x 1200 mm

Construction details:

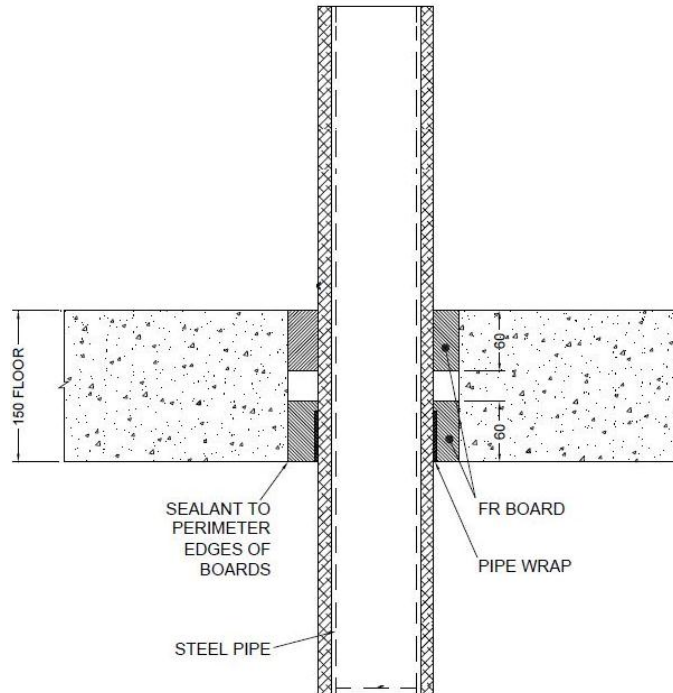

**A.5.3.1**

Services	Wrap	Insulation	Classification
Mild or stainless steel pipe			
40 mm diameter/ 1-14.2 mm wall	50 x 1.8 mm Joints Fire Wrap Pro+	13 mm Kaiflex ST insulation	<b>E 180 C/U, EI 120 C/U</b>

#### A.5.4 Joints Fire Wrap Pro+ penetration seal for insulated metal pipes, in 2x Joints Fire Board Pro+ 2-S (back to back), in rigid floors

**Penetration Seal:** CS (Continuous Sustained) insulated metallic and composite pipes fitted at any position within the aperture (min. separation 40 mm from seal edges and 100 mm from other services), with two layers of 60 mm Joints Fire Board Pro+ 1-S installed together to either side of the floor (or anywhere in between). Joints Fire Wrap Pro+ are required to be fitted around combustible pipe insulation at the bottom of the seal. Maximum aperture size 2400 mm x 1200 mm

Construction details:

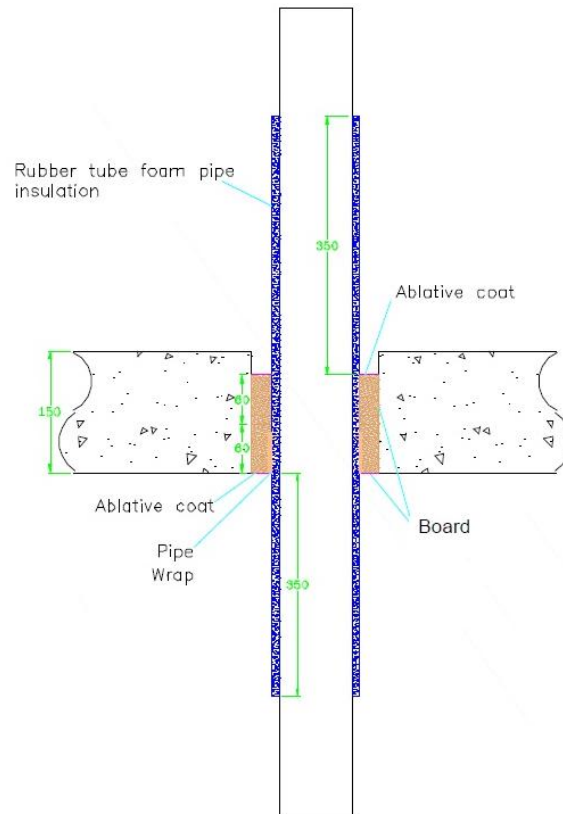

**A.5.4.1**

Services	Wrap	Insulation	Classification
Copper pipe	50 x 3.6 mm Joints Fire Wrap Pro+ fitted to both sides of the seal	9-13 mm Kaiflex ST insulation	<b>E240 C/C, EI 60 C/C</b>
12-54 mm diameter/1-1.2 mm wall		13-25 mm Kaiflex ST insulation	<b>E 180 C/C, EI 45 C/C</b>
12-54 mm diameter/1-1.2 mm wall			
<b>Geberit Mepla MLC (PE-Xb/Aluminium/PE-HD pipe)</b>			
16 mm diameter/2.25 mm wall	50 x 3.6 mm Joints Fire Wrap Pro+ fitted to both sides of the seal	9 mm Kaiflex ST insulation	<b>EI 120 C/C</b>
20 mm diameter/2.5 mm wall			
26 mm diameter/3 mm wall			
32 mm diameter/3 mm wall			
40 mm diameter/3.5 mm wall			
50 mm diameter/4 mm wall			
63 mm diameter/4.5 mm wall			
75 mm diameter/4.7 mm wall			
16 mm diameter/2.25 mm wall		13-25 mm Kaiflex ST insulation	<b>E 60 C/C, EI 45 C/C</b>
20 mm diameter/2.5 mm wall			
26 mm diameter/3 mm wall			
32 mm diameter/3 mm wall			
40 mm diameter/3.5 mm wall			
50 mm diameter/4 mm wall			
63 mm diameter/4.5 mm wall			
75 mm diameter/4.7 mm wall			



## A.6 Flexible or rigid wall constructions with wall thickness of minimum 100 mm

### A.6.1 Joints Fire Wrap Pro+ penetration seal for insulated metal pipes, in 2x Joints Fire Board Pro+ 1-S, in flexible or rigid walls

**Penetration Seal:** CS (Continuous Sustained) insulated metallic pipes fitted at any position within the aperture (min. separation 40 mm from seal edges and 100 mm from other services), with 50 mm Joints Fire Board Pro+ 1-S to both sides of the wall. Joints Fire Wrap Pro+ are required to be fitted around the pipe insulation. Maximum aperture size 2400 mm x 1200 mm.

Construction details:

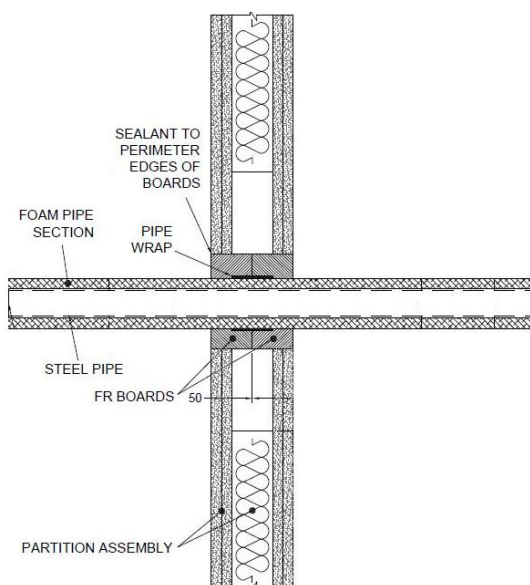

#### A.6.1.1

Services	Wrap	Insulation	Classification
Mild or stainless steel pipe			
40 mm diameter/1-14.2 mm wall	50 x 1.8 mm Joints Fire Wrap Pro+ fitted centrally	13 mm Kaiflex ST insulation	EI 120 U/C, EI 120 U/U, EI 120 C/U, EI 120 C/C
40 mm diameter/1-14.2 mm wall*	2 off 50 x 3.6 mm Joints Fire Wrap Pro+, one fitted flush to each face of seal	13 - 32mm Kaiflex ST insulation	E 120 U/C, E 120 U/U, E 120 C/U, E 120 C/C, EI 60 U/C, EI 60 U/U, EI 60 C/U, EI 60 C/C
50 mm diameter/1.3-14.2 mm wall*			
60 mm diameter/1.6-14.2 mm wall*			
75 mm diameter/2-14.2 mm wall*			
90 mm diameter/2.4-14.2 mm wall*			
100 mm diameter/2.7-14.2 mm wall*			
115 mm diameter/3.1-14.2 mm wall*			
140 mm diameter/3.8-14.2 mm wall*			
165 mm diameter/ 4.5-14.2 mm wall*			

\* Typical pipe diameters shown, see below graph for intermediate sizes

Pipe diameter vs Wall thickness

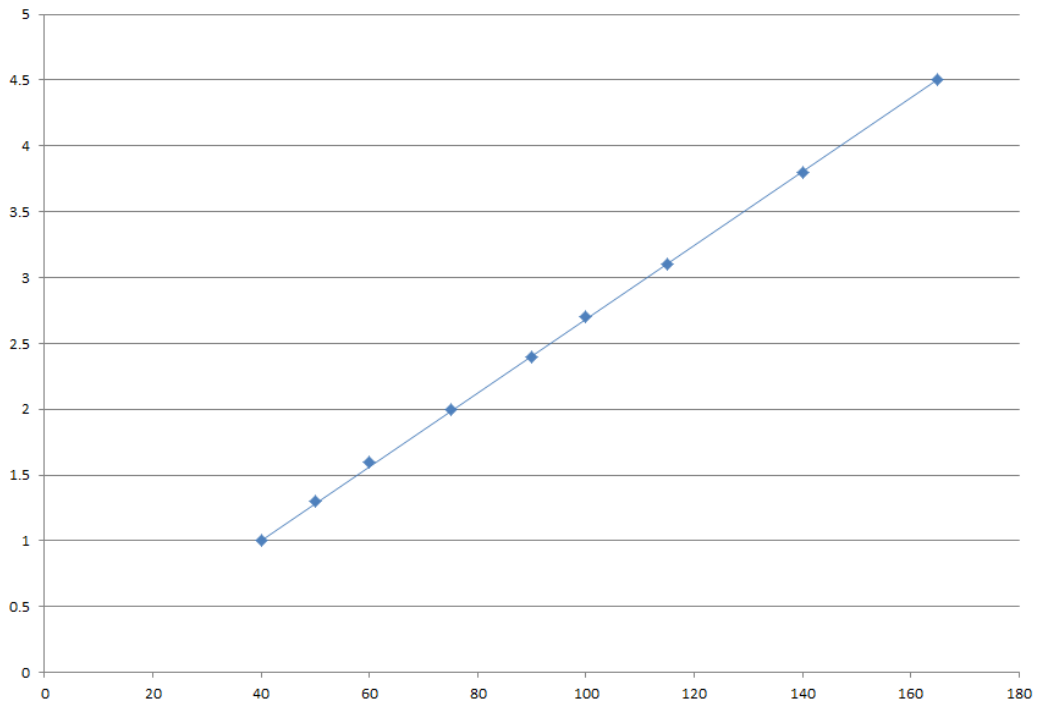

### A.6.2 Joints Fire Wrap Pro+ penetration seal for insulated metal pipes, in 2x Joints Fire Board Pro+ 1-S, in flexible or rigid walls

**Penetration Seal:** LS (Local Sustained) or CS (Continuous Sustained) insulated metallic and composite pipes (single) fitted at any position within the aperture (min. separation 40 mm from seal edges and 100 mm from other services), with 50 mm Joints Fire Board Pro+ 1-S to both sides of the wall. Joints Fire Wrap Pro+ are required to be fitted around the pipe to both sides of the seal. Maximum aperture size 2400 mm x 1200 mm.

Construction details:

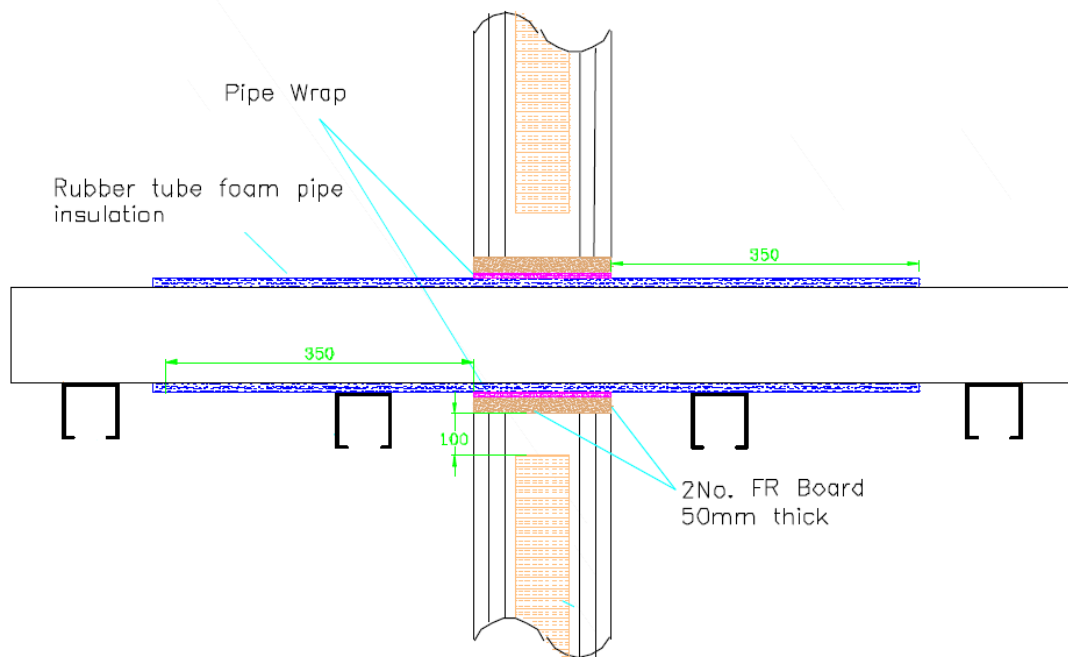

#### A.6.2.1

Services	Wrap	Insulation	Classification	
Copper pipe	50 x 3.6 mm Joints Fire Wrap Pro+ fitted to both sides of the seal	9 mm Kaiflex ST insulation	EI 120 C/C	
12 mm diameter/1 mm wall		9-13 mm Kaiflex ST insulation	E 120 C/C, EI 90 C/C	
12-54 mm diameter/1-1.2 mm wall		13-25 mm Kaiflex ST insulation	E 120 C/C, EI 60 C/C	
12-54 mm diameter/1-1.2 mm wall	50 x 3.6 mm Joints Fire Wrap Pro+ fitted to both sides of the seal	9-25 mm Kaiflex ST insulation	EI 120 C/C	
Geberit Mepla MLC (PE-Xb/Aluminium/PE-HD pipe)				
16 mm diameter/2.25 mm wall				
20 mm diameter/2.5 mm wall				
26 mm diameter/3 mm wall				
32 mm diameter/3 mm wall				
40 mm diameter/3.5 mm wall				
50 mm diameter/4 mm wall				
63 mm diameter/4.5 mm wall				
75 mm diameter/4.7 mm wall				

**A.6.3 Joints Fire Wrap Pro+ penetration seal for insulated metal pipes, in 2x Joints Fire Board Pro+ 1-S, in flexible or rigid walls**

**Penetration Seal:** Combustible pipes (single) fitted central within the aperture, with Joints Fire Board Pro+ 1-S to both sides of the wall. Joints Fire Wrap Pro+ are required to be fitted around the pipe. Maximum aperture size 2400 mm x 1200 mm

Construction details:

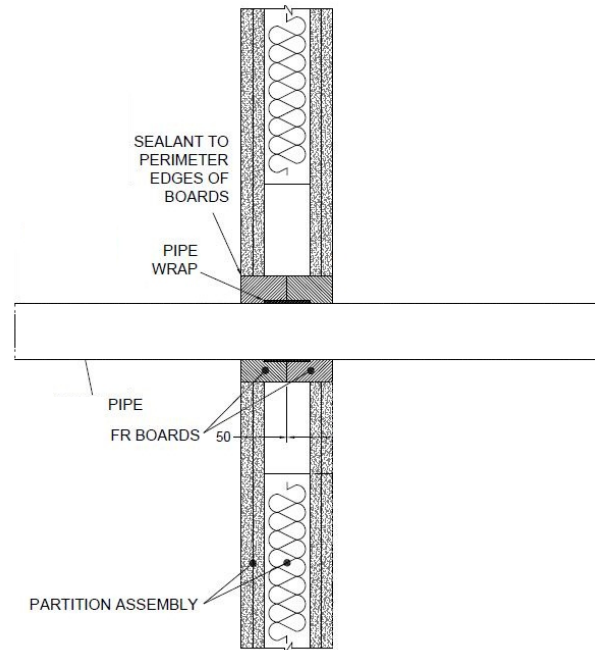

**A.6.3.1**

Services	Pipe Wrap	Classification
PVC-U pipe according to EN 1329-1, EN 1452-1 and EN 1453-1* and PVC-C according to EN 1566-1 315 mm $\varnothing$ /9.2 mm wall	Joints Fire Wrap Pro+ 75 x 18 mm fitted centrally around the pipe	<b>EI 45 C/C</b>

\* In Germany the pipes have additionally to comply with DIN 19531-10

**A.6.4 Joints Fire Wrap Pro+ penetration seal for plastic pipes, in 2x Joints Fire Board Pro+ 1-S, in flexible or rigid walls**

**Penetration Seal:** Combustible pipes sealed with Joints Fire Wrap Pro+, to both sides of the wall backed with Stonewool (35kg/m<sup>3</sup> density), 25 mm deep. Minimum separation between penetration seals and seal edges of 30 mm.

Construction details:

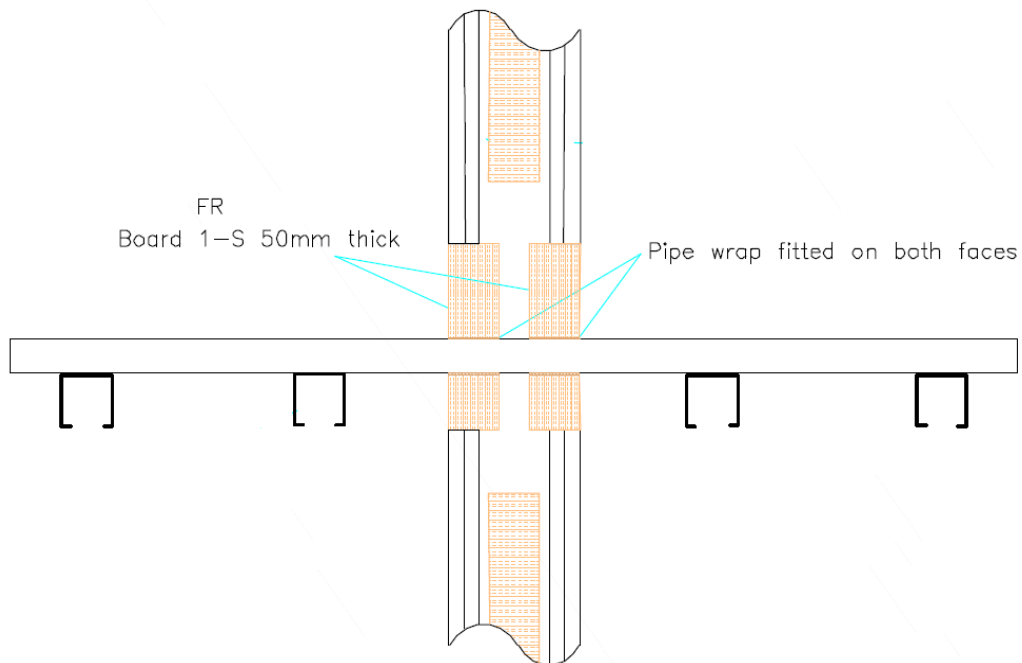

**Configuration 1**

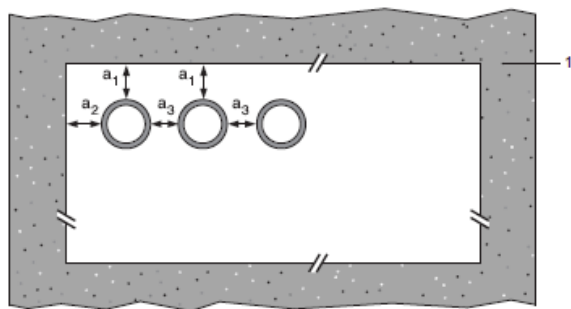

**Configuration 2**

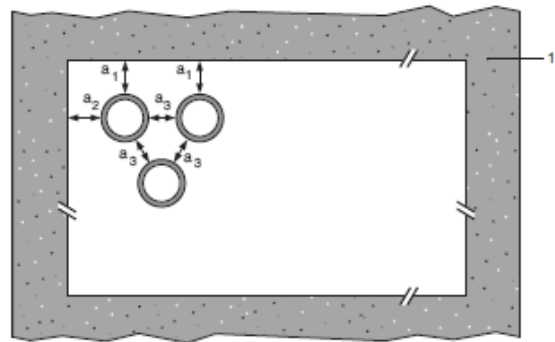

**Key**

- 1 Supporting construction
- a1 Pipe / top edge of seal separation
- a2 Pipe / side edge of seal separation
- a3 Pipe / pipe separation

#### A.6.4.1

Services	Wraps (both sides)	Permitted configuration for seal separation	Classification
PVC-U pipe according to EN 1329-1, EN 1452-2 and EN 1453-1 <sup>^</sup> and PVC-C according to EN 1566-1			
Diameter up to 40 mm, wall thickness 1.9 – 3.0 mm	50 x 1.8 mm (1 layer)	1 & 2 between PVC-U/PVC-C, PE/ABS/SAN+PVC and PP pipes in any combination	EI 120 U/U, EI 120 C/U, EI 120 U/C, EI 120 C/C
Diameter up to 110 mm, wall thickness 2.7 - 6.6 mm	50 x 3.6 mm (2 x 1.8 layer)		E 120 U/C, E 120 C/C EI 90 U/C, EI 90 C/C
Diameter up to 125 mm, wall thickness 3.7 – 7.4 mm	50 x 5.4 mm (3 x 1.8 layer)		
Diameter up to 160 mm, wall thickness 9.5 mm	50 x 7.2 mm (4 x 1.8 layer)		
PE pipe according to EN 1519-1, EN 12201-2 and EN 12006-1 <sup>§</sup> , ABS according to EN 1455-1 and pipes made from SAN+PVC according to EN 1565-1			
Diameter up to 40 mm, wall thickness 2.4 – 3.7 mm	50 x 1.8 mm (1 layer)	1 & 2 between PVC-U/PVC-C, PE/ABS/SAN+PVC and PP pipes in any combination	EI 120 U/U, EI 120 C/U, EI 120 U/C, EI 120 C/C
Diameter up to 110 mm, wall thickness 4.2 - 10 mm	50 x 3.6 mm (2 x 1.8 layer)		E 120 U/C, E 120 C/C EI 90 U/C, EI 90 C/C
Diameter up to 125 mm, wall thickness 4.8 – 12 mm	50 x 5.4 mm (3 x 1.8 layer)		
Diameter up to 160 mm, wall thickness 14.6 mm	50 x 7.2 mm (4 x 1.8 layer)		
PP pipe according to EN 1852-1: 2009			
Diameter up to 40 mm, wall thickness 1.8 – 5.5 mm	50 x 1.8 mm (1 layer)	1 & 2 between PVC-U/PVC-C, PE/ABS/SAN+PVC and PP pipes in any combination	EI 120 U/U, EI 120 C/U, EI 120 U/C, EI 120 C/C
Diameter up to 110 mm, wall thickness 2.7 - 15.1 mm	50 x 3.6 mm (2 x 1.8 layer)		EI 90 U/U, EI 90 C/U, EI 90 U/C, EI 90 C/C
Diameter up to 125 mm, wall thickness 3.1 – 17.1 mm	50 x 5.4 mm (3 x 1.8 layer)		
Diameter up to 160 mm, wall thickness 21.9 mm	50 x 7.2 mm (4 x 1.8 layer)		

<sup>§</sup> In Germany the pipes have additionally to comply with DIN 19535-10

<sup>^</sup> In Germany the pipes have additionally to comply with DIN 19531-10

**A.6.5 Penetration seal in JOINTS FIRE COMPOUND PRO+ seals, in flexible\* and rigid walls minimum 100 mm thick**

**Penetration Seal:** Combustible pipes sealed with Joints Fire Wrap Pro+, installed into JOINTS FIRE COMPOUND PRO+ seals. Minimum separation between penetration seals and seal edges of 30 mm.

Construction details:

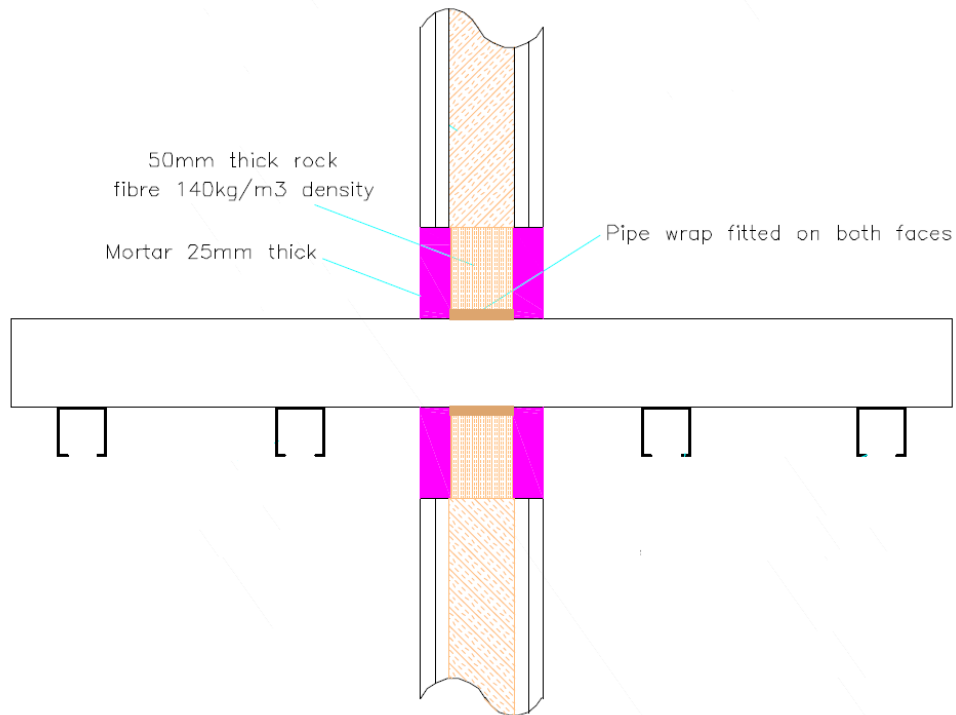

**Configuration 1**

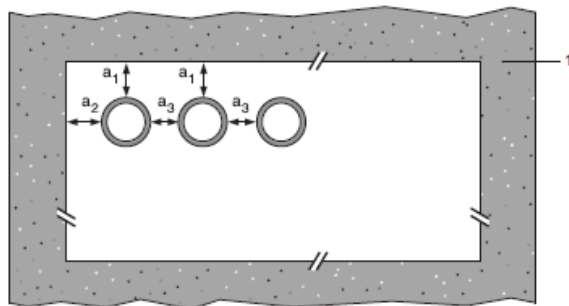

**Configuration 2**

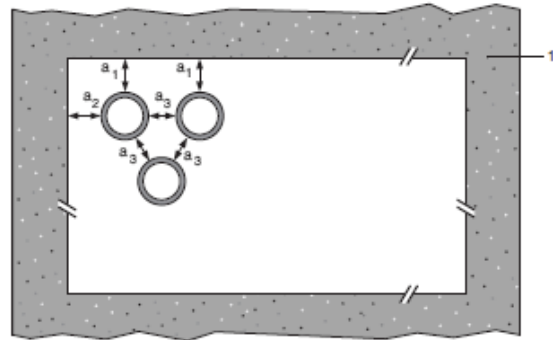

**Key**

- 1 Supporting construction
- a1 Pipe / top edge of seal separation
- a2 Pipe / side edge of seal separation
- a3 Pipe / pipe separation

**\* Partition wall must incorporate a full fill core insulation of Stonewool (35kg/m3 density)**

### A.6.5.1

Services	Wraps (both sides)	Permitted configuration for seal separation	Classification
PVC-U pipe according to EN 1329-1, EN 1452-2 and EN 1453-1 <sup>^</sup> and PVC-C according to EN 1566-1			
Diameter up to 40 mm, wall thickness 3.0 – 4.3 mm	50 x 1.8 mm (1 layer)	1 & 2 between PVC-U/PVC-C, PE/ABS/SAN+PVC and PP pipes in any combination	E 120 U/C, E 120 C/U, EI 60 U/C, EI 60 C/C
Diameter up to 110 mm, wall thickness 2.7 - 6.6 mm	50 x 3.6 mm (2 x 1.8 layer)		E 120 U/C, E 120 C/C EI 90 U/C, EI 90 C/C
Diameter up to 125 mm, wall thickness 3.7 – 7.4 mm	50 x 5.4 mm (3 x 1.8 layer)		EI 120 U/C, EI 120 C/C
Diameter up to 160 mm, wall thickness 3.2 - 9.5 mm	50 x 7.2 mm (4 x 1.8 layer)		EI 60 U/C, EI 60 C/C
PE pipe according to EN 1519-1, EN 12201-2 and EN 12006-1 <sup>§</sup> , ABS according to EN 1455-1 and pipes made from SAN+PVC according to EN 1565-1			
Diameter up to 40 mm, wall thickness 3.2 – 3.7 mm	50 x 1.8 mm (1 layer)	1 & 2 between PVC-U/PVC-C, PE/ABS/SAN+PVC and PP pipes in any combination	EI 120 U/C, EI 120 C/C
Diameter up to 110 mm, wall thickness 4.2 - 10 mm	50 x 3.6 mm (2 x 1.8 layer)		EI 60 U/C, EI 60 C/C
Diameter up to 125 mm, wall thickness 12 mm	50 x 5.4 mm (3 x 1.8 layer)		EI 120 U/C, EI 120 C/C
Diameter up to 160 mm, wall thickness 4.9 – 12.0 mm	50 x 7.2 mm (4 x 1.8 layer)		E 120 U/C, E 120 C/C
Diameter up to 160 mm, wall thickness 12.0 mm			EI 90 U/C, EI 90 C/C
PP pipe according to EN 1852-1: 2009			
Diameter up to 40 mm, wall thickness 4.0 – 5.5 mm	50 x 1.8 mm (1 layer)	1 & 2 between PVC-U/PVC-C, PE/ABS/SAN+PVC and PP pipes in any combination	EI 120 U/C, EI 120 C/C
Diameter up to 110 mm, wall thickness 6.6 mm	50 x 3.6 mm (2 x 1.8 layer)		E 120 U/C, E 120 C/C EI 90 U/C, EI 90 C/C
Diameter up to 125 mm, wall thickness 17.1 mm	50 x 5.4 mm (3 x 1.8 layer)		E 120 U/C, E 120 C/C EI 90 U/C, EI 90 C/C
Diameter up to 160 mm, wall thickness 4.0 - 21.9 mm	50 x 7.2 mm (4 x 1.8 layer)		E 120 U/C, E 120 C/C
Diameter up to 160 mm, wall thickness 21.9 mm			EI 60 U/C, EI 60 C/C

<sup>§</sup> In Germany the pipes have additionally to comply with DIN 19535-10

<sup>^</sup> In Germany the pipes have additionally to comply with DIN 19531-10