

Filtration & Monitoring Solutions for hydraulic oil and lubricants

Introduction to Oil Cleanliness



PURE POWER

Fluid is one of the most critical components in a hydraulic system



Introduction

In hydraulics, fluid is one of the most critical components. Its main function is to serve as a medium to transmit power, but it can also be used to dissipate heat, lubricate, seal clearances between moving parts or transport contaminants. Once a hydraulic system is operational, contaminants will find their way into the hydraulic fluid and affect the physical and chemical composition. This contamination causes numerous problems, including:

- ▶ Component breakdown
- ▶ Reduced hydraulic fluid and equipment life
- ▶ Decrease in system efficiency
- ▶ Machine downtime
- ▶ High maintenance costs

The financial losses that come along with this process can become a heavy burden, especially when breakdown occurs in critical systems and interrupts the continuation of business processes. There are various ways of monitoring and maintaining fluid condition, but to solve the problem, it's important to first understand it.

This guide is intended to help the user in decision making about hydraulic fluid filtration. The selection and correct use of a filtration system is important to increase operational reliability while reducing manufacturing and maintenance costs.

Content

Introduction	3
Sources of Contamination	6
Measurement	8
Contamination Types	9
Damage Caused by Contamination	17
Oil Sampling	20
Quantifying Solid Particle Contamination	23
ISO Cleanliness Levels	27
Cleanliness Selection Guide	29
Types of Hydraulic Fluid	30
Filtration Types	32
Types of Filtration Media	33
Reactive Maintenance	38
Preventive Maintenance	38
Condition Based Maintenance	39
Solutions	42
Solutions for Solid Contamination	43
Solutions for Contaminated Air	44
Solutions for Water Contamination	44
Solutions for Acids	45
Condition Monitoring Solutions	46
Conversion Tools	48

Contamination



Sources of Contamination

Contamination in a hydraulic system is impossible to completely avoid. To determine the best long term solution to remove and prevent contamination, it is important to first identify the source.

The four sources

Contaminated new fluid

When commissioning or topping up a hydraulic system, it is often assumed that the new hydraulic fluid is clean. However, the fluid is transported and stored in containers, tanks and transport systems before entering the hydraulic system, which implies risks of contamination.

Contaminated components

Although maintenance is important, it is also a source of contamination. In addition to the increased chance of ingress contamination, every new component installed, is a potential risk of contamination.

Ingress contamination

Particles from the surrounding air enter the hydraulic fluid through (temporary) openings in the hydraulic system. This can be reservoir breathers, leaking cylinder rod seals or when the hydraulic system is opened for maintenance.

Internally generated contamination

Contamination can also develop within the hydraulic system. For example changes in temperature cause condensation leading to water contamination and friction of components can cause solid contamination in the hydraulic fluid.



FACT

Most contamination enters through conventional breathers and cylinder rod glands

New fluid is not clean fluid and must be filtered before use

Contamination sources in a hydraulic system

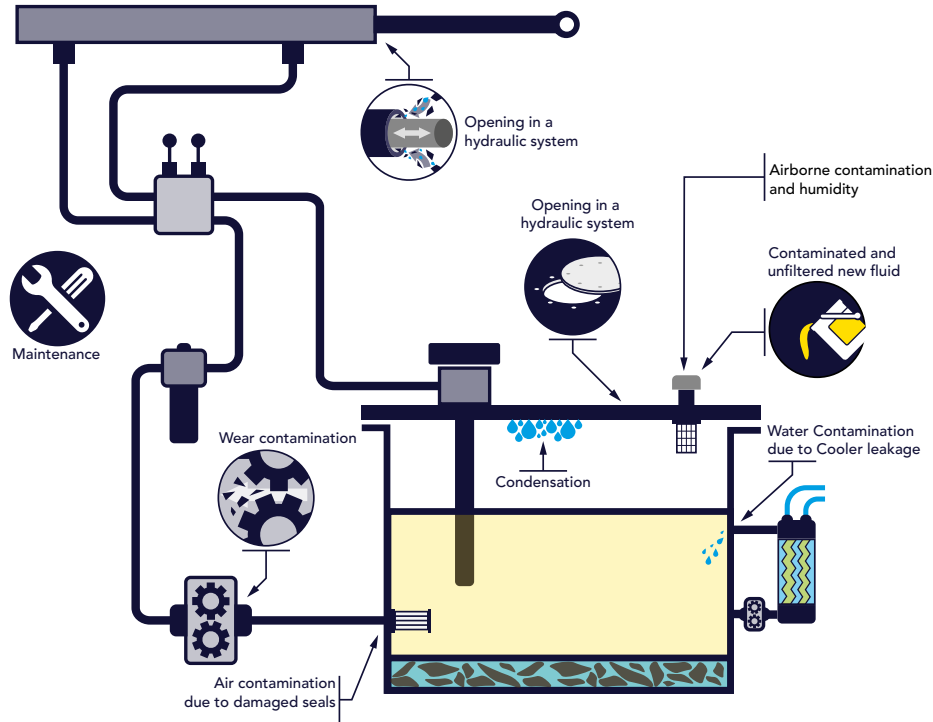

Additional filtration solution

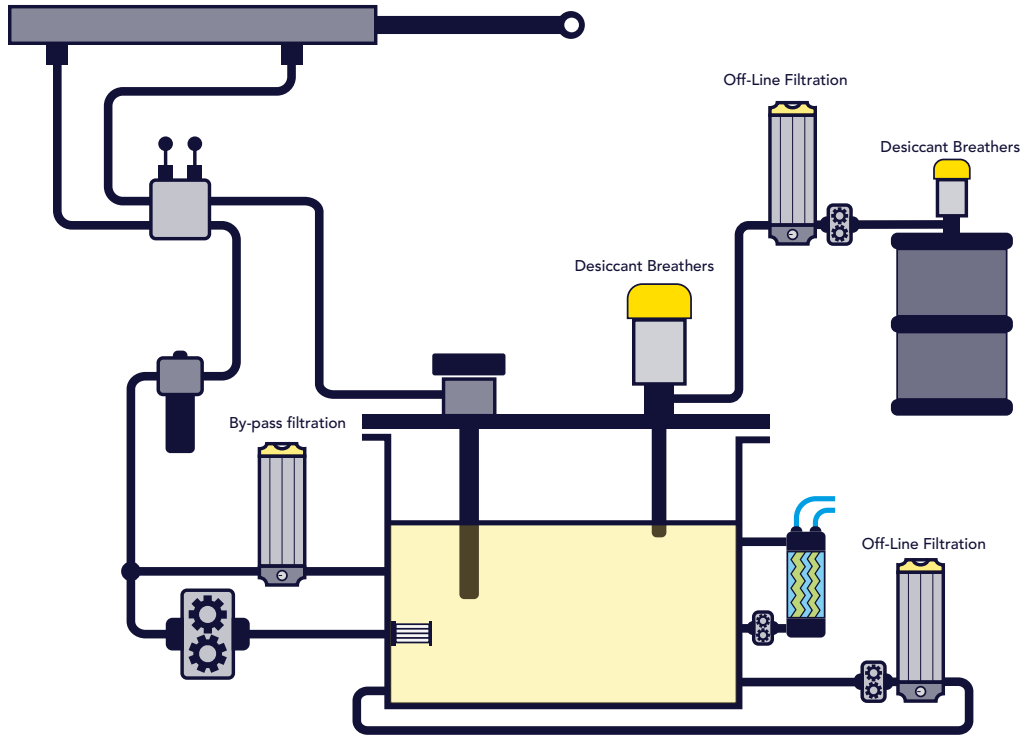

Measurement

Particle size

Contaminants come in various sizes, mostly as particles of microscopic size, invisible to the human eye. The particles are measured on micrometre scale.

Micrometre scale

One micrometre ("µm" or "micron") is one-millionth of a meter, 39 millionths of an inch. The human eye can detect particles larger than approximately 40 microns. Particles that damage hydraulic or lubrication systems are mostly smaller than 40 microns.

Most available filtration units are able to remove particles over 3 micron, but fall short when it comes to smaller particles. Unfortunately these smaller particles, also known as silt, can cause serious damage to hydraulic systems.

FACT
Additives in hydraulic fluid are generally well below 1 micron in size and are unaffected by standard filtration methods

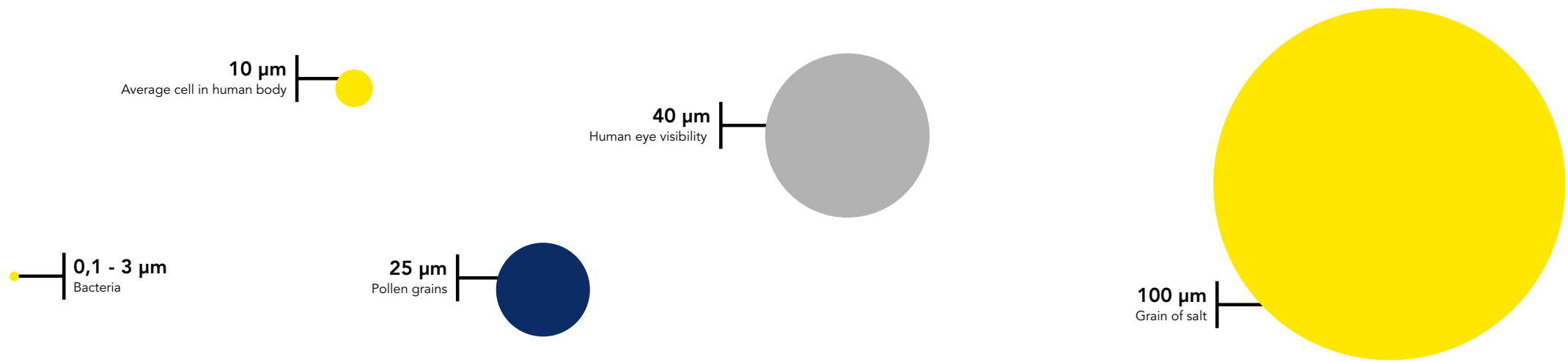

Contamination Types

Every form of contamination damages a system in its own way and requires a different treatment. To ensure the best filtration solution, it is important to determine the type of contamination.

1 Solid contamination

2 Acid

3 Soft contamination

4 Water contamination

5 Air contamination

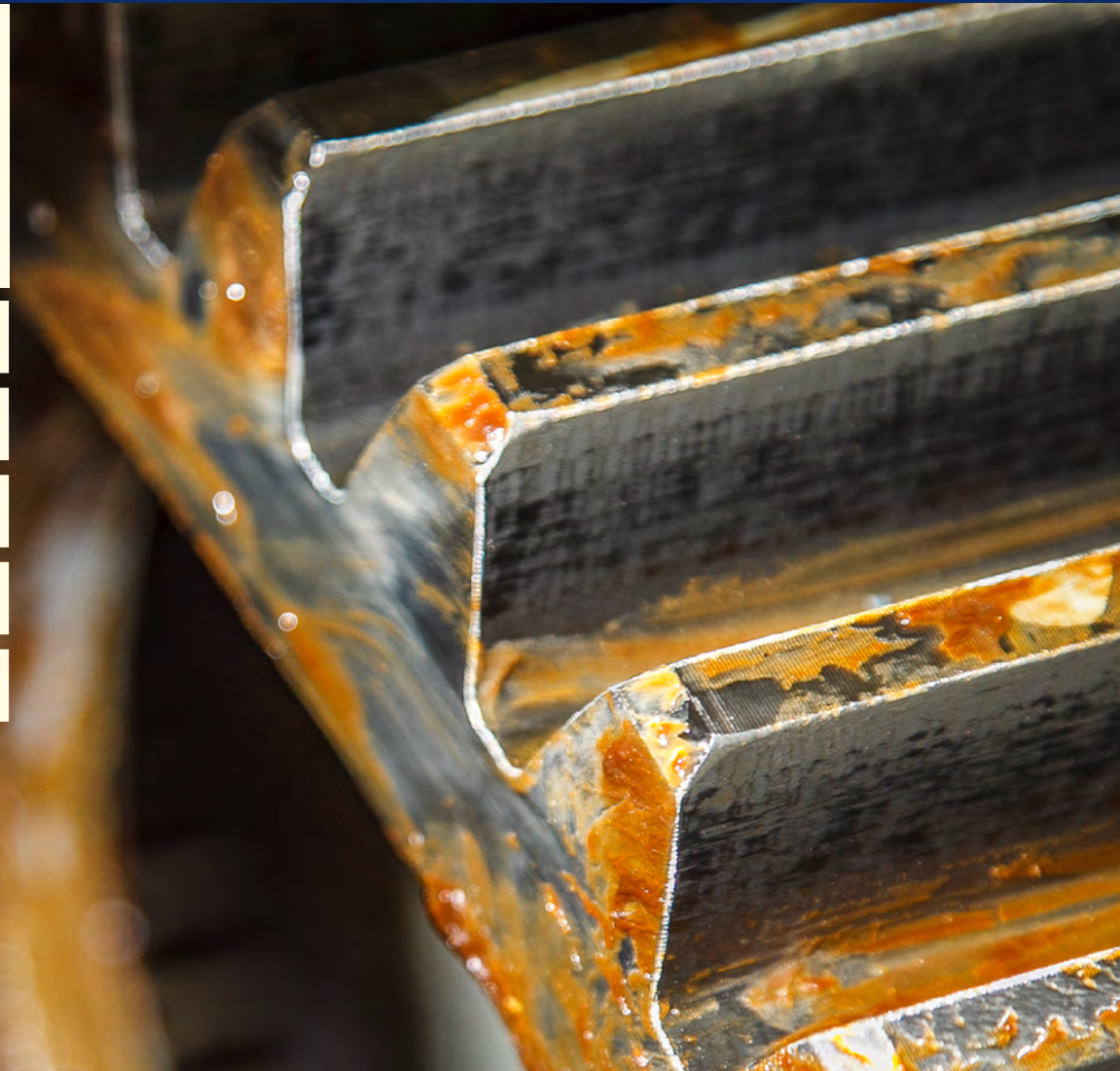

Solid Contamination

Solid contamination is most of the time an insoluble contamination type that won't dissolve in oil or other liquids. Solid contaminants like metal, sand and rubber but also salt and ice crystals can be recognised by:

- ▶ The presence of contamination in the tank
- ▶ Damaged seals
- ▶ Clogged valves
- ▶ Accelerated oil oxidation and deterioration

Solid contamination can cause the following problems: abrasion, adhesion, fatigue, erosion and silting.

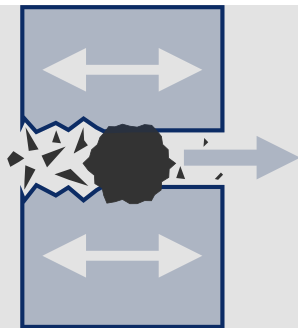

Abrasion

Abrasion occurs when a large solid contamination particle gets stuck between two moving components and digs itself into one of them, scratching and damaging the surface of both moving components.

Abrasive wear effects

- ▶ Dimensional changes to system
- ▶ Valve leakage
- ▶ Lower system efficiency

Components typically subject to abrasion

- ▶ Hydraulic components like pump, motor, spool valves and cylinders
- ▶ Journal bearings

Adhesion

Adhesion occurs when the oil film thickness decreases to a point that metal-to-metal contact starts occurring, resulting in surface weld and shear.

Adhesive wear effects

- ▶ Valve leakage
- ▶ Lower system efficiency
- ▶ Component breakdown

Components typical subject to adhesion

- ▶ Hydraulic cylinders
- ▶ Ball and journal bearings

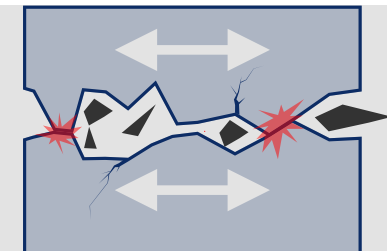



Fatigue

Fatigue occurs when solid particles get stuck and repeatedly dent the component's surface, resulting in surface cracking and damage. Due to fatigue the particle will get released to start damaging another part of the system.

Fatigue wear effects

- ▶ Leakage
- ▶ Deterioration of component surface
- ▶ Cracking of component surface

Components typical subject to fatigue wear

- ▶ Journal, hydrostatic and rolling element bearings
- ▶ Geared system

Erosion

Erosion occurs when particles impact and damage the component surfaces by removing material.

Erosive wear effects

- Dimensional changes to system
- Valve leakage
- Disfunctional valves or nozzle spray pattern

Components typical subject to erosion

- Pump
- Valves (servo, proportional, directional)
- Nozzle

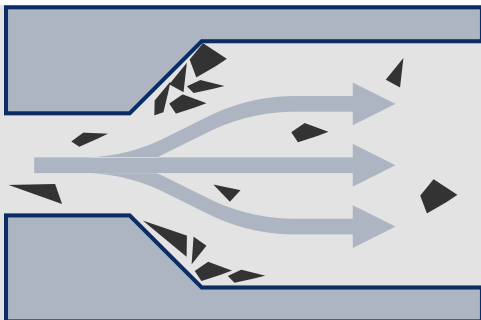

Silting

Silting occurs when solid particles build-up in the hydraulic system.

Silting effects

- ▶ Clogged valves
- ▶ Slow response, instability
- ▶ Spool jamming/stiction
- ▶ Solenoid burnout
- ▶ Impacts heat transfer characteristics

Components typical subject to silting

- ▶ Valves (servo, proportional, directional)
- ▶ Heat exchangers
- ▶ Cylinders

Acids

One of the main reasons of degradation of hydraulic fluid is oxidation, a chemical reaction between oxygen and hydrocarbon molecules in the fluid. Hydraulic oxidative degradation is rated by the Acid Number (AN) / Total Acid Number (TAN). It displays the amount of potassium hydroxide (KOH) in milligrams that is needed to neutralize the acids in one gram of oil.

Effects acids

- ▶ Fluid gets darker
- ▶ Increased viscosity
- ▶ Development of varnish and sludge



Soft Contamination

Soft contaminants are another insoluble contamination type causing problems for a wide range of hydraulic applications, especially turbines. Soft contaminants can lead to the formation of varnish. Contaminated fluid containing metal and moisture particles will oxidise, which results in fluid degradation and a rising Total Acid Number (TAN), and eventually in the formation of varnish. This process will be accelerated by temperature fluctuations (heat) which cause hot spots.

Varnish creates a sticky film on the components of the hydraulic system, catching all sorts of particles. This continues to build up, forming an abrasive and destructive surface film that results in sticky deposits adhering to the metal surfaces of the oil loop, e.g. piping, valves, heat exchangers, filters and other sensitive equipment. Varnish is one of the most underestimated contaminants that will lead to a reduced service life of your fluids, filters and system and will cause unscheduled downtime and maintenance.



- ▶ Less effective heat exchangers
- ▶ Increased wear of valves, load gears, and bearing surfaces
- ▶ Reduced hydraulic fluid life
- ▶ Premature filter change-outs and oil flow restrictions
- ▶ Increased oil leakage

Soft contaminants will also cause sludge, a soft dark substance which moves around in the hydraulic system until coming to rest at the bottom.

Effects of sludge

- ▶ Monday morning disease
- ▶ Clogged of valves
- ▶ Increased operating temperature
- ▶ Corrosion

Water Contamination

Solid contamination is often considered as the biggest cause of hydraulic and lubrication failure. However water contamination can cause many problems like corrosion and oil degradation by oxidation. The water concentration in a hydraulic fluid is marked as RH percentage (relative humidity), ppm (parts per million) or % (percentage weight or volume).

Water state

Water can be present in a hydraulic or lubrication fluid as dissolved or free water. Dissolved water develops when individual water molecules bind with oil molecules. As these water molecules are too small to see with the naked eye, it will not change the colour of the fluid, it will remain clear.

Each type of oil has its own "saturation point" at which oil can't hold any more water molecules. Most common saturation points will be between 200 and 600 ppm (0,02

– 0,06 percent) depending on the temperature of the oil. At a higher temperature the oil will be able to hold more water. Also aged fluids can dissolve more water. After the saturation

point is reached and more water enters the system, emulsion will be created. The state of the hydraulic fluid will change from clear to a cloudy, milky substance. Adding more water to this emulsion leads to free water, which is mostly found on the bottom of oil reservoirs due to the higher specific density.

To minimise the damaging effects of free water, the concentration of water in oil should be as low as possible and well below the oil saturation point. We

recommend a maximum saturation level of 40-50% at operating temperature for H, HL, HLP and HVLP fluids*. Dielectric fluids should be maintained at an even lower saturation level.

Water Concentration

10,000 PPM	1 %
1,000 PPM	0,1 %
100 PPM	0,01 %

*PPM- Parts per million

FACT

Hydraulic fluid holds more water at high temperature

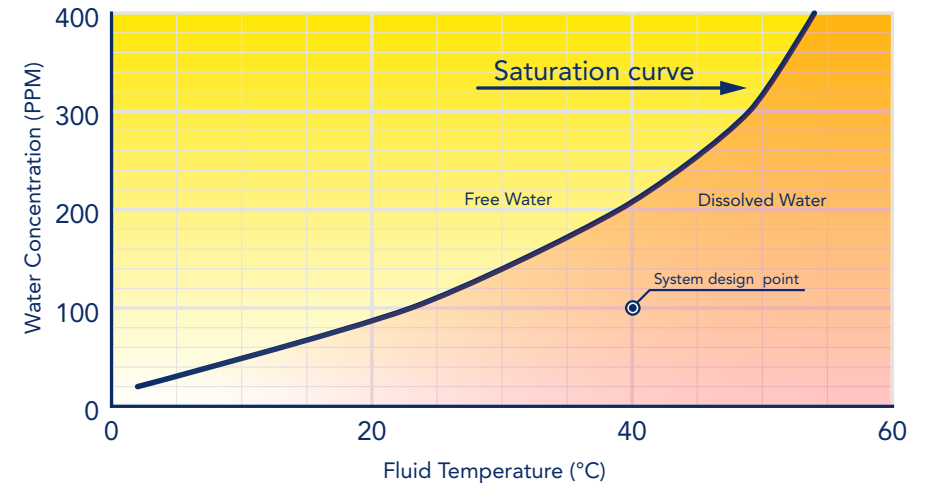

*See page 28-29 for explanation.

Effects of water contamination

The first sign of water contamination is a change in viscosity. This will result in reduced lubrication thickness causing metal-to-metal contact. The combination of free water with small copper or iron particles created by wear will have a catalytic effect on the oxidation.

Free water also penetrates microscopic pores in the metal surfaces, causing corrosion of

the system's components. Corrosion particles will spread through the system, causing the formation of new corrosion in the tank and the cycle continues.

Water contamination will also cause depletion of additives which results in loss of dielectric strength, oxidation, accelerated metal surface fatigue and oil breakdown.

Water contamination can be recognised by:

- ▶ Condensation in tank
- ▶ Rust in tank and oil circuit
- ▶ Pump cavitation & erosion

Water contamination effects

- ▶ Oil oxidation & deterioration
- ▶ Reduced lubricating film thickness
- ▶ Corrosion
- ▶ Accelerated metal surface fatigue
- ▶ Loss of dielectric strength in insulating oils

Typical oil saturation levels*

Different hydraulic fluids have their own saturation point.

- ▶ Hydraulic: 200-400 PPM (0.02-0.04 %)
- ▶ Lubrication: 200-750 PPM (0.02-0.075%)
- ▶ Dielectric: 30-50 PPM (0.003-0.005 %)
- ▶ Industrial Phosphate Ester: 1000-3000 PPM (0.1-0.3 %)

*Actual levels will depend on oil type temperature and additives.

FACT

At freezing temperatures the formation of ice crystals can have severe damaging effects

Oil degradation due to catalytic effect.

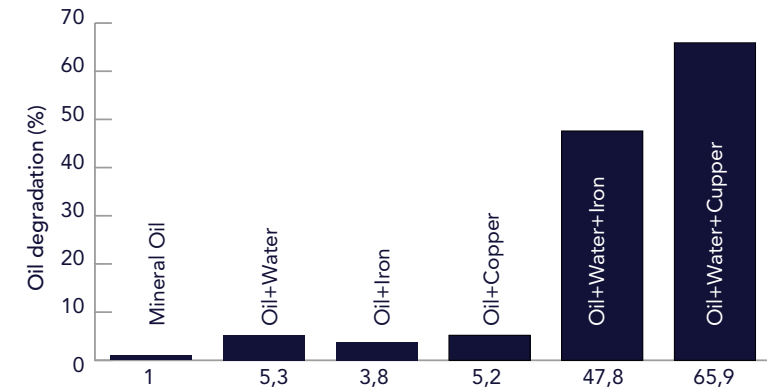

Effects of water contamination on life cycle of bearings.

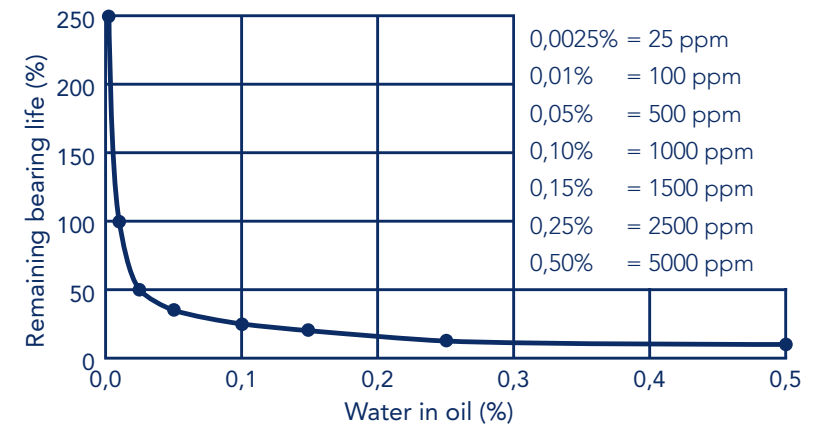

Air Contamination

Inside a hydraulic system, air can exist in a dissolved or free state. Dissolved air will not pose a problem, free air on the other hand will become a problem when it passes through system components. It can cause pressure changes that compress the air and produce a large amount of heat in small air bubbles. This heat can destroy both additives and the hydraulic liquid itself.

If the amount of free air reaches a certain level, it will have a negative effect on the productivity of the system. Hydraulic systems rely on the fluid being relatively incompressible, while air reduces the volume of the liquid. This is due to the fact that air is far more compressible than the liquid in which it is dissolved. When air is present, a pump has to put more energy into compressing the air, therefore there is less energy left for operating the system. A system in this state is said to be 'spongy'.

Air in both dissolved and free state is a potential source of oxidation, accelerating the corrosion of metal parts. Both produce oxides which promote the formation of particles or form sludge. Wear and interference increase if oxidation debris is not prevented or removed.

DAMAGE

- ▶ Loss of transmitted power
- ▶ Reduced pump output
- ▶ Loss of lubrication
- ▶ Increased operating temperature
- ▶ Reservoir fluid foaming
- ▶ Chemical reactions

SOURCES

- ▶ System leaks
- ▶ Pump aeration
- ▶ Reservoir fluid turbulence
- ▶ Low oil level in reservoir (splashing)

PREVENTION

- ▶ System air bleeds
- ▶ Flooded suction pump
- ▶ Proper reservoir design
- ▶ Return line diffusers
- ▶ Desiccant Breathers



Damage Caused by Contamination

Lubrication thickness

In hydraulic systems moving surfaces are separated by the lubrication fluid. The lubrication thickness is determined by the viscosity of the fluid, the load on and speed of the moving surfaces.

High mechanical loads can cause the lubrication thickness to decrease to less than 1µm. This in combination with surface wear and roughness (particles) increases the risk of the lubrication film becoming corrupted, causing metal-to-metal friction with harmful results.

Typical Dynamic Clearances

COMPONENT	DETAILS	CLEARANCE
Valves	Servo	1 - 4 µm
	Proportional	1 - 6 µm
	Directional	2 - 8 µm
Variable Volume Piston Pumps	Piston to Bore	5 - 40 µm
	Valve Plate to Cylinder block	0.5 - 5 µm
Vane Pumps	Tip to Case	0.5 - 1 µm
	Sides to Case	5 - 13 µm
Gear Pumps	Tooth Tip to Case	0.5 - 5 µm
	Tooth to Side Plate	0.5 - 5 µm
Ball Bearings	Film Thickness	0.1 - 0.7 µm
Roller Bearings	Film Thickness	0.1 - 1 µm
Journal Bearings	Film Thickness	0.5 - 100 µm
Seal	Seal and Shaft	0.05 - 0.5 µm
Gears	Mating Faces	0.1 - 1 µm

*Ref. ASME (American Society of Mechanical Engineers) Wear Handbook

The following failures can occur:

- ▶ Orifice blockages
 - ▶ Orifice blockages in pilots of poppet/proportional/servo valves
 - ▶ Jammed pistons in pumps or vanes in rotor slots
 - ▶ Component wear
 - ▶ Abrasive wear
 - ▶ Erosive wear
 - ▶ Adhesive wear
 - ▶ Fatigue wear
 - ▶ Corrosive wear
- ▶ Corrosion
- ▶ Degradation of the surface
- ▶ Depletion of additives and their protective ability
- ▶ Biological growth
 - ▶ Microbes and fungi can be found in hydraulic systems in water and air, producing acids that attack metal surfaces, causing
 - ▶ Acid smell of oil and oil can look slimy
 - ▶ Increase in fluid viscosity
 - ▶ Reduced hydraulic fluid life
 - ▶ Clogged filter elements
 - ▶ Increased presence of sediment

FACT

To know system cleanliness is the first step
in contamination management

Oil Analysis



Oil Sampling

Oil sampling can give you information on your oil quality and contamination level. It provides insight in which proactive actions should be taken to achieve optimal machine performance, reliability and lowest possible costs. Frequent oil sampling can help determine critical contamination levels and provide insight in which actions should be taken to achieve optimal machine performance and reliability.

There are 3 different methods to determine oil quality:

1 Online monitoring

2 Portable

3 Laboratory

Online oil monitoring

Online oil monitoring solutions are permanently fitted in a hydraulic system and are the most reliable. Various sensors within the system measure the particle size, water content and oil degradation. By trending these parameters it gives a representative image of the oil quality. Corrective actions can be carried out at an early stage, preventing damage to the system.

Portable oil sampling

Portable oil sampling is a relatively good solution for on-site measurement of particle size and Relative Humidity (RH) percentage. Service engineers can immediately analyse the results and take action. Using a portable sampling unit can reduce laboratory sampling to once a year, resulting in less waiting time and cost savings.

Laboratory oil sampling

Laboratory oil analysis provides the most detailed information on the quality of the oil. A laboratory report can incorporate a particle and wear metal count, membrane picture, water analysis, and viscosity, TAN level and additive package check.

Not sure which measurement method suits your application best?
RMF Systems can help you find the optimal
sampling solution for your situation.

Which sampling method is right for my application?

All three methods have their advantages. To decide which solution suits your application, the following should be taken into account:

- ▶ Available space to implement a sampling unit
- ▶ Number of machines to be sampled
- ▶ Frequency of sampling
- ▶ Total cost of sampling
- ▶ Criticality of machines

How to take a representative sample

There are a few common mistakes when taking an oil sample:

- ▶ Incorrect sampling point
- ▶ Inconsistent sampling point
- ▶ Reusing an old sample bottle
- ▶ Taking a sample without flushing the sampling point first

To ensure consistent and representative results, the sampling conditions must always be the same. Therefore ensure to document the sample location, flush volume, frequency, timing within a cycle and indicate what tools and accessories were used.

Location

There are a few locations in a hydraulic system which provide you with a representative sample.

Good sampling points are:

- ▶ Before pressure filter
- ▶ Return line before filter
- ▶ Oil reservoir (last resort)

Off-line filter units often have a sample point at the base of the housing. When this is not the case, find a sampling point between the pump and filter.

Frequency

The frequency of sampling is determined by the criticality of a hydraulic system. Critical systems need a higher sampling frequency to ensure operational reliability. For systems that are less critical sampling every six months should be sufficient. The Oil sampling frequency chart can help you determine the sampling frequency. The indications "Good", "Warning" and "Bad" might differ per system. Most component builders have specified typical oil cleanliness levels and lifetime of the component.

Please contact RMF Systems for more information or advise on choosing the most suitable method for your application.

Oil Sampling frequency

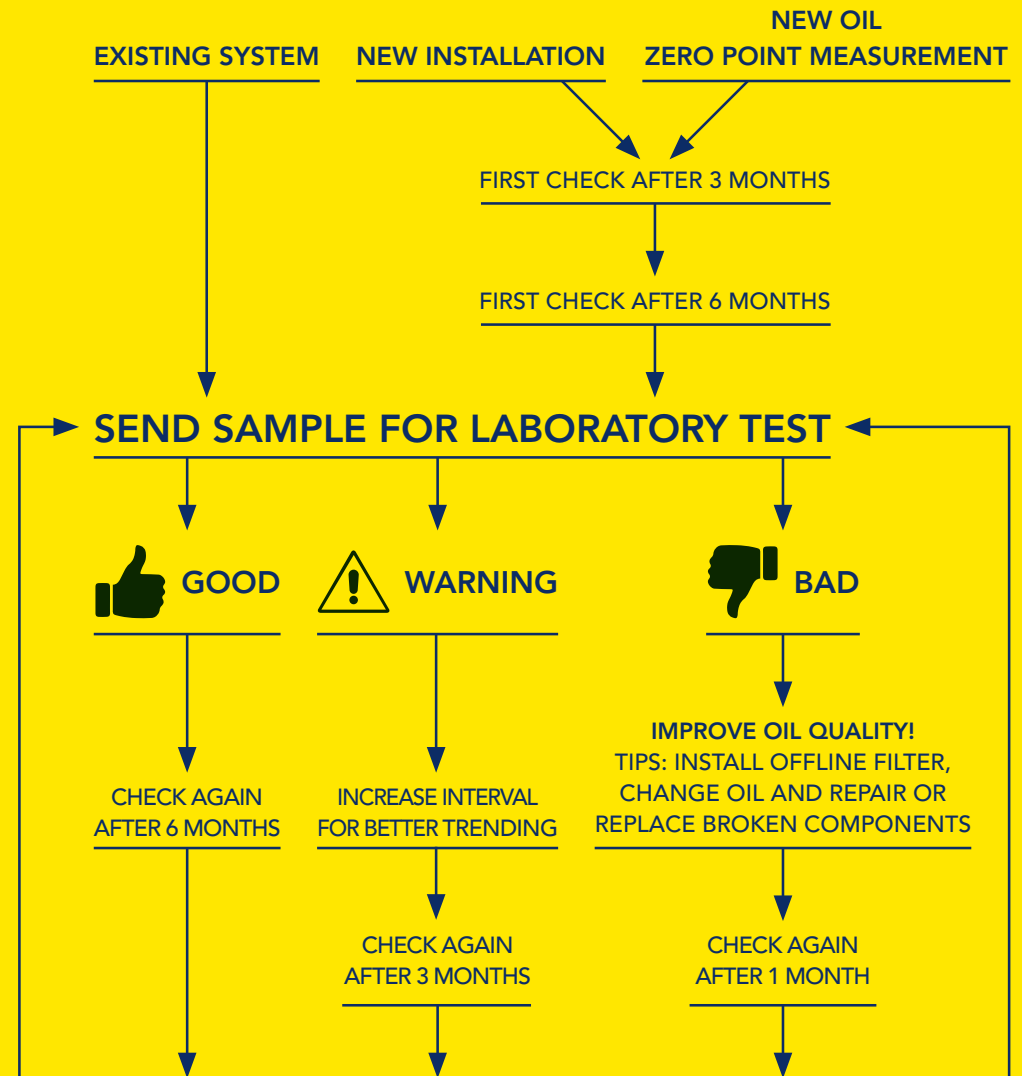

Procedure for taking an oil sample

Before taking a sample always make sure the hydraulic system is in stable operation and follow the procedure below to get the most out of a laboratory oil analysis.

Requirements:

- ▶ A certified particle free glass or hard plastic sampling bottle (approximately 100-200 ml)
- ▶ An open oil container or bucket (approximately 2 litres)
- ▶ A sampling hose

Steps

- 1 Connect the sampling hose to the sampling point and flush between 1 and 2 litres into the oil container
- 2 Place the sampling bottle carefully under the sampling hose without disconnecting the hose from the valve
- 3 Fill the bottle for approximately 80%
- 4 Immediately place the cap on the bottle after taking the sample
- 5 Close the valve and unplug the sampling hose
- 6 Fill out the label on the sample bottle
- 7 Pack the sampling bottle properly and send it for laboratory testing

FACT

There are different classes
in certification of cleanliness
of sampling bottles

Quantifying Solid Particle Contamination

ISO 4406:1999

Developed by the International Organization for Standardization, the ISO Range Code is the commonly used cleanliness code. The ISO 4406 code records the cleanliness level of a hydraulic liquid by three numbers. These numbers correspond with the amount of particles respectively larger than 4, 6 and 14 micron per 100ml. As there are always more small particles than large particles, the ISO code numbers always go from high to low (example: 17/15/13).

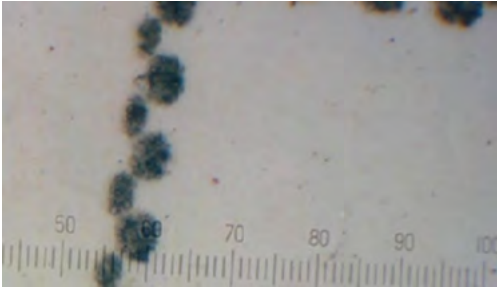

ISO 16/14/11 – NAS 6

Microscopic view of a cleanliness level that is commonly required by OEM. This sample contains 40 thousand particles per 100 ml.

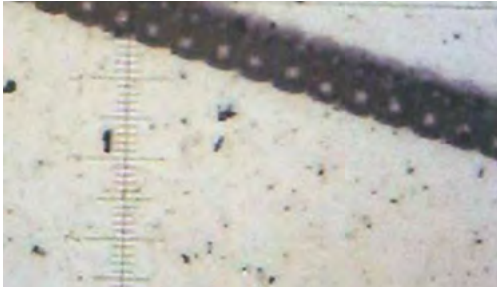

ISO 23/21/18 – NAS 12

Microscopic view of highly contaminated hydraulic fluid. This sample contains more than 4 million particles per 100 ml.

Example:
 Larger than 4 μm = 125,000
 Larger than 6 μm = 29,490
 Larger than 14 μm = 4,250

	4 μ	6 μ	14 μ
250,000,000			28
130,000,000			27
64,000,000			26
32,000,000			25
16,000,000			24
8,000,000			23
4,000,000			22
2,000,000			21
1,000,000			20
500,000			19
250,000			18
130,000	17		17
64,000			16
32,000		15	15
16,000			14
8,000			13
4,000			12
2,000			11
1,000			10
500			9
250			8
130			7
64			6
32			5
16			4
8			3
4			2
2			1
1			0
0.5			

NAS 1638

NAS 1638 (National Aerospace Standard) is an American standard originated in the aerospace industry to determine contamination levels of fluid in hydraulic components.

NAS 1638 divides particles in five size classes:

- ▶ 5 to 15 μm / 100 ml
- ▶ 15 to 25 μm / 100 ml
- ▶ 25 to 50 μm / 100 ml
- ▶ 50 to 100 μm / 100 ml
- ▶ 100 or higher μm / 100 ml

These five size classes combined with the particle distribution result in 14 different classes with "00" being the cleanest and "12" the dirtiest. The class with the highest amount of particles counted, is referring to the fluid's NAS class.



Maximum particles / 100ml in specified size range (μm)

	00	0	1	2	3	4	5	6	7	8	9	10	11	12
5-15	125	250	500	1000	2000	4000	8000	16000	32000	64000	128000	256000	512000	1024000
15-25	22	44	89	178	356	712	1425	2850	5700	11400	22800	45600	91200	182400
25-50	4	8	16	32	63	126	253	506	1012	2025	4050	8100	16200	32400
50-100	1	2	3	6	11	22	45	90	1801	360	720	1410	2880	5760
≥ 100	0	0	1	1	2	4	8	16	32	64	128	256	512	1024

SAE AS 4059

Since 2001 the SAE Aerospace Standard (AS) replaces the NAS 1638 standard for all new designs.

Table 1: Cleanliness classes for differential particle counts

SAE AS 4059 is identical to ISO 11218. SAE AS 4059 table 1 displays the maximum contamination limits (particles/100ml). Particles are categorised in five size groups in accordance with ISO 11171. The particle count is displayed by class, from 00 to 14.

	6 to 14 µm	14 to 21 µm	21 to 38 µm	38 to 70 µm	>70 µm
00	125	22	4	1	0
0	250	44	8	2	0
1	500	89	16	3	1
2	1.000	178	32	6	1
3	2.000	356	63	11	2
4	4.000	712	126	22	4
5	8.000	1.425	253	45	8
6	16.000	2.850	506	90	16
7	32.000	5.700	1.012	180	32
8	64.000	11.400	2.025	360	64
9	128.000	22.800	4.050	720	128
10	256.000	45.600	8.100	1.440	256
11	512.000	91.200	16.200	2.880	512
12	1.024.000	182.400	32.400	5.760	1.024

Table 1 Cleanliness classes for differential particle counts (particles/100ml)

Table 2: Cleanliness classes for cumulative particle counts

SAE AS 4059 table 2 displays particle size in category A to F and particle count per category in class 000 to 12.

SIZE	>4 µm(c)	>6 µm(c)	>14 µm(c)	>21 µm(c)	>38 µm(c)	>70 µm(c)
SIZE CODE	A	B	C	D	E	F
000	195	76	14	3	1	0
00	390	152	27	5	1	0
0	780	304	54	10	2	0
1	1.560	609	109	20	4	1
2	3.120	1.217	217	39	7	1
3	6.250	2.432	432	76	13	2
4	12.500	4.864	864	152	26	4
5	25.000	9.731	1.731	306	53	8
6	50.000	19.462	3.462	612	106	16
7	100.000	38.924	6.924	1.224	212	32
8	200.000	77.849	13.849	2.449	424	64
9	400.000	155.698	27.698	4.898	848	128
10	800.000	311.396	55.396	9.796	1.696	256
11	1.600.000	622.792	110.792	19.592	3.392	512
12	3.200.000	1.245.584	221.584	39.184	6.784	1.024

Table 2 Cleanliness classes for cumulative particle counts (particles/100ml)

** The information reproduced in these tables is a brief extract from SAE AS4059 Rev. E revised in May 2005. For further details and explanations please see the full Standard.

GOST 17216-200

The GOST standard was introduced by Russian government and adopted by the Inter-governmental committee of standardization metrology. GOST divides particles in five groups by size. The group with the highest amount of particles will represent the contamination level.

SIZE RANGE	5 - 10 μm	10 - 25 μm	25 - 50 μm	50 - 100 μm	>100 μm
00	8	4	1	0	0
0	16	8	2	0	0
1	32	16	3	0	0
2	63	32	4	1	0
3	125	63	8	2	0
4	250	125	12	3	0
5	500	250	25	4	1
6	1.000	500	50	6	2
7	2.000	1.000	100	12	4
8	4.000	2.000	200	25	6
9	8.000	4.000	400	50	12
10	16.000	8.000	800	100	25
11	31.500	16.000	1.600	200	50
12	63.000	31.500	3.150	400	100
13	-	63.000	6.300	800	200
14	-	125.000	12.500	1.600	400
15	-	-	25.000	3.150	800
16	-	-	50.000	6.300	1.600
17	-	-	-	125.000	3.150

ISO Cleanliness Levels

Achieving the correct cleanliness level

Knowing the cleanliness level of a fluid forms the basis for contamination control measures. Different components require different cleanliness levels. RMF Systems created an overview to help you determine the optimal cleanliness level for your system.

By selecting the most sensitive component used in the system in the left hand column and the amount of pressure in the top row you can determine the recommended ISO class level.

FACT

Every hydraulic component has a manufacturers specified ISO cleanliness level

	LOW/MEDIUM PRESSURE 140 BAR AND LOWER	HIGH PRESSURE 140-210 BAR	VERY HIGH PRESSURE 210 BAR AND HIGHER
	MODERATE CONDITIONS	SEVERE CONDITIONS	HIGH PRESSURES AND SEVERE CONDITIONS
PUMPS			
Fixed gear/Fixed vane	20/18/15	19/17/14	18/16/13
Fixed piston	19/17/14	18/16/13	17/15/12
Variable vane	18/16/13	17/15/12	Not applicable
Variable piston	18/16/13	17/15/12	16/14/11
VALVES			
Check valves	20/18/15	20/18/15	19/17/14
Directional valves	20/18/15	19/17/14	18/16/13
Standard flow valves	20/18/15	19/17/14	18/16/13
Cartridge valves	19/17/14	18/16/13	17/15/12
Proportional valves	17/15/12	17/15/12	16/14/11
Servo valves	16/14/11	16/14/11	15/13/10
ACTUATORS			
Cylinders, Vane motors, Gear motors	20/18/15	19/17/14	18/16/13
Piston motors, Swash plate, Gear motors	19/17/14	18/16/13	17/15/12
Hydrostatic drives	16/15/12	16/14/11	15/13/10
Test stands	15/13/10	15/13/10	15/13/10
BEARINGS			
Journal bearings	17/15/12	Not applicable	Not applicable
Industrial gear boxes	17/15/12	Not applicable	Not applicable
Ball bearings	15/13/10	Not applicable	Not applicable
Roller bearings	16/14/10	Not applicable	Not applicable



FACT

Disposal of contaminated fluid can cost over 5 times the cost of new oil.

Cleanliness Selection Guide

Fluid viscosity

The viscosity is the fluid's resistance to shear or flow and shows the adhesive / cohesive or frictional fluid property. The resistance is caused by intermolecular friction exerted when layers of fluids attempt to slide by one another. The viscosity rating is needed for correct design of required temperatures for storage, pumping or injection of fluids. There are two related measures of fluid viscosity known as dynamic (or absolute) and kinematic viscosity.

Viscosity Conversion Chart

cSt (Centistokes)*	SUS (Saybolt Universal Seconds)
10	46
20	93
25	116
30	139
32.4	150
40	185
50	232
70	324
90	417

*Comparisons are made at 100°F (38°C). For other viscosity conversion approximations, use the formula: Centistokes (cSt) = Saybolt Universal Seconds (SUS) / 4.635 at 100° F

Viscosity Classification

KINEMATIC VISCOSITY MM ² /S AT 40°C (104°F)			
ISO VISCOSITY GRADE	MIDPOINT	MINIMUM	MAXIMUM
ISO VG 2	2.2	1.98	2.42
ISO VG 3	3.2	2.88	3.52
ISO VG 5	4.6	4.14	5.06
ISO VG 7	6.8	6.12	7.46
ISO VG 10	10	9.00	11.0
ISO VG 15	15	13.5	16.5
ISO VG 22	22	19.8	24.2
ISO VG 32	32	29.8	35.2
ISO VG 46	46	41.4	50.6
ISO VG 68	68	61.2	74.8
ISO VG 100	100	90.0	110
ISO VG 150	150	135	165
ISO VG 220	220	198	242
ISO VG 320	320	288	352
ISO VG 460	460	414	506
ISO VG 680	680	612	748
ISO VG 1000	1000	900	1100
ISO VG 1500	1500	1350	1650
ISO VG 2200	2200	1980	2420
ISO VG 3200	3200	2880	3520

Types of Hydraulic Fluid

Hydraulic fluids are formulated depending on the application and the required properties

Mineral fluids

The most frequently used hydraulic base fluid also known as hydraulic oil.

		Suitable sealing material
H and HH	No additives (<i>is no longer used in practice</i>)	NBR
HL	Extra additives to increase the corrosion protection and resistance to aging	
HM	Extra additives to increase the corrosion protection and resistance to aging and to reduce wear due to scoring in the mixed friction area	
HLP	Extra additives in addition to HL oil to reduce wear and protect against corrosion and oxidation	
HV and HVLP	Like HLP, but with increased resistance to aging, as well as an improved temperature-viscosity relationship	
HLPD	Like HLP, but with additives to improve particle transport (detergent effect) and dispersion capacity (water carrying capacity)	

Biodegradable fluids

Biodegradable hydraulic fluids are produced using plant oils and used in biologically critical environments.

		Suitable sealing material
HE	Hydraulic Environmental	NBR
HETG	Triglyceride baseplant oils	NBR
HEES	Synthetic ester base	FPM
HEPG	Polyglycol base,	FPM
HEPR	Other base liquids, primarily Poly-alpha-olefins	FPM

Flame resistant fluids

		Suitable sealing material
HFAE	Oil in water emulsions	NBR
HFAS	Synthetic concentrates dissolved in water	NBR
HFB	Water in oil emulsions	FPM
HFC	Water glycols	NBR
HFD	Synthetic liquids	FPM



Filtration

Filtration is used to separate contamination from a fluid by forcing the fluid through a filtration medium. The fluid is forced through the filtration medium, leaving contamination particles behind in the filter.

Filtration Types

Filtration protects hydraulic systems from contamination and therefore from malfunctions, breakdowns and expensive oil changes. Filtration can take place in several different ways or combinations.

System filtration

Suction filtration

Suction filtration prevents the ingress of large particles (150 - 200 μm) from the fluid reservoir into the system's circuit and is a basic form of filtration that doesn't contribute to the cleanliness level. Suction filters are usually placed between the pump and the inlet pipe with flanges.



Pressure filtration

Pressure filtration has a typical filter fineness between 3 and 20 μm and can be used to protect the whole system, part of the system or just a component immediately downstream of the pump.

Return filtration

Return filtration is the most common form of fluid filtration. Return filtration takes place on the return line, in or on the hydraulic reservoir just before the fluid returns to the reservoir.



Additional filtration

Bypass filtration

Bypass filters act as a kidney loop, draining oil from the main system. After oil is been filtered it returns to the system oil reservoir. The amount of oil extracted to be filtered is insignificant ensuring the filtration won't affect the operation of the main system. By using elements with different filter fineness higher fluid cleanliness can be achieved.



Offline filters

With offline filtration oil is extracted from the main system by an external pump, which makes it possible to filter the oil even when the main system is not in operation. Changing filter elements is made easy and can also be done without interrupting the main system.



Air filters

Air filters clean the air before it enters the oil reservoir. This air can be highly contaminated due to the (dusty) environment. Only a limited number of air filters are capable of removing both water and solid particles from the air, which significantly reduces the oxidation process.



Types of Filtration Media

The filtration medium is the part of the filter element that catches the contamination particles. Filter media are generally classified as either surface or depth media.

Surface filtration

With surface type filter media, the fluid flows in a straight line through the medium surface. Contamination particles are captured on the media surface that is facing the fluid flow. Surface type filter elements are generally made from woven wire, the most common media include wire mesh, cellulose, fiberglass composites, or other synthetic materials. The filtration media are woven into a sheet shape before being pleated. By pleating this sheet, the surface area will be increased to create a higher, a higher Dirt Holding Capacity (DHC) and less pressure difference. Sometimes the filtration medium has multiple layers and mesh backing to achieve certain performance criteria.

The surface area has a consistent pore size, the diameter of the largest solid spherical particle that will pass through the medium under specified test conditions determines the filter fineness. However, over time the build-up of contaminants on the surface will allow the medium to capture particles smaller than the pore size rating. On the other hand, particles that have a smaller diameter, but may be longer in length (such as a fibre strand), may slip through the surface.

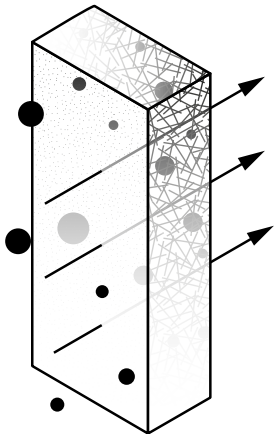
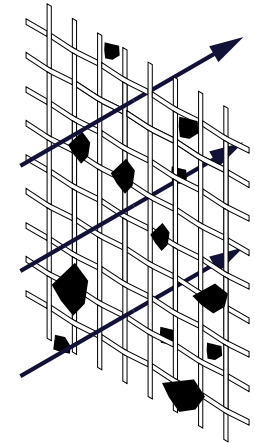

Depth filtration

With depth type filtration the fluid is forced through the filtration medium in indirect paths and particles are getting captured in the maze of openings within the medium.

Depth filtration media usually start out as a pulp cellulose, consisting of fibres of different lengths. This pulp is rolled out into a thin sheet. To create a depth filtration element over 200 layers of sheet are winded around the core of a filter element. Because of this construction, a depth filtration medium has pores of many different sizes. Depending on the pore sizes and time required for the oil to pass through the filtration element, this depth filtration media can be very efficient in captioning very small particles.

Filtration Flow Direction

Besides the filtration type and filtration media, the filtration flow direction is also important when determining the right filtration type for your application. In contrast to surface filtration which always has a radial flow direction, depth filtration can go in two different directions, either the axial or radial flow direction.

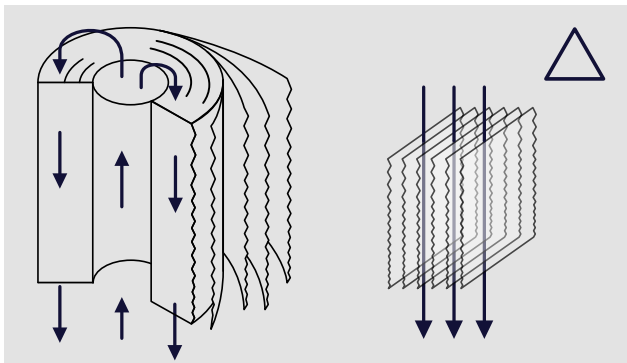

Axial filtration

An axial fluid flow is created between the filtration medium layers, the fluid flows through the filter element from top to bottom. Contaminants are captured in the filter media, which can lead to a common problem: channel forming.

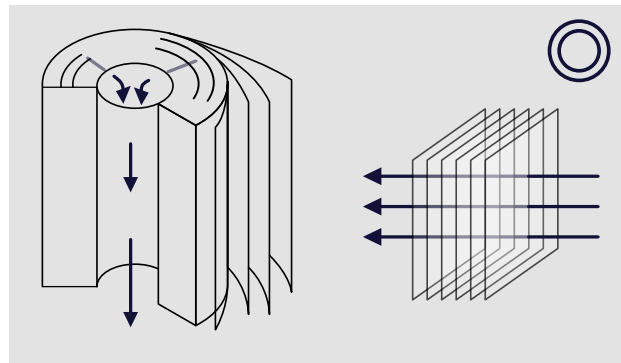

Radial filtration

In contrast to axial filtration the fluid flow in radial filtration is from the outside in, through all filtration medium layers. This eliminates channel forming due to the various flow paths.

FACT
RMF Systems depth filtration
can increase fluid life time
3-10 times.

The Multipass Test

When filtering fluid flows through a filtration element. At some point in time the filter element will be completely saturated and the pressure difference will rise. Saturated filter elements need to be changed in order to ensure efficient filtration of the oil.

One method to evaluate the filter element performance is by the ISO 4572 "Multipass Test Procedure", recognised by ANSI* and NFPA**. During this test, fluid circulates through the circuit under controlled and monitored conditions. The differential pressure is recorded while a constant amount of contaminant is injected upstream (before) of the element. On-line laser particle sensors determine the contaminant levels upstream

and downstream (after) of the element. With this information, the performance attribute (Beta ratio) can be determined for several particle sizes.

Three element performance characteristics can be measured with the Multipass Test:

1. Dirt holding capacity
2. Pressure differential of the filter element
3. Filtration efficiency, expressed as a "Beta Ratio"

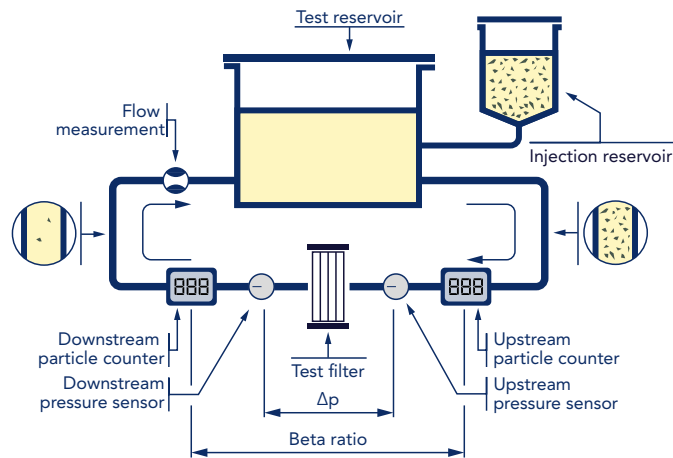

ANSI* - American National Standards Institute is a private non-profit organisation that controls the development of standards for products, services processes and personnel in the United States.

NFPA** - National Fire Protection Association is a United States organisation that creates and maintains private, copyrighted standards and codes.

Example

We start by comparing the upstream and downstream particle count. Let's assume 50,000 particles of 10µm and larger were counted upstream of the filter element and 10,000 particles at the same size range were counted downstream.

We divide the particles upstream by the particles downstream to calculate the Beta ratio, which in this example equals 5 (Beta = 50,000/10,000 = 5).

$$B_x = \frac{\text{\# of particles upstream}}{\text{\# of particles downstream}}$$

"x" is at a specific particle size

$$B_{10} = \frac{50,000}{10,000} = 5$$

With the Beta ratio we can calculate the filter's dirt holding capacity. This can be found by the following equation:

$$\text{Efficiency} = (1 - 1/\text{Beta}) * 100 = 80\%$$

$$\text{Efficiency}_x = \left(1 - \frac{1}{\text{Beta}}\right) 100$$

$$\text{Efficiency}_{10} = \left(1 - \frac{1}{5}\right) 100 = 80\%$$

This means the filter tested was 80% efficient at removing particles of 10µm and larger.

The Beta ratio / efficiencies table shows some common Beta ratio numbers and their corresponding efficiencies.

BETA RATIOS/EFFICIENCIES

Beta Ratio (at a given particle size)	Capture Efficiency (at same particle size)
1.01	1.0%
1.1	9.0%
1.5	33.3%
2.0	50.0%
5.0	80.0%
10.0	90.0%
20.0	95.0%
75.0	98.7%
100	99.0%
200	99.5%
1000	99.9%

Component life extension due to additional filtration

We compare two systems that have a pump with a flow of 250 l/min running 24 hours a day 7 days a week. We take a 100 ml oil sample, which shows the ISO cleanliness level of the first system is ISO 23/21/18 and the cleanliness level of the second systems is ISO 16/14/11.

In table 1 we compare the number of particles between the systems based on the oil sample.

Number of particles in 100 ml of sampled fluid		
	System 1	System 2
	ISO 23/21/18	ISO 16/14/11
Particles larger than 4 µm	4.000.000 - 8.000.000	32.000 - 64.000
Particles larger than 6 µm	1.000.000 - 2.000.000	8.000 - 16.000
Particles larger than 14 µm	130.000 - 250.000	1.000 - 2.000

Table 1

Based on this example each year 4375kg of dirt passes through the pump of the first system. The expected service life of this pump will be approximately 2 years. In the second system only 25kg of dirt passes through the pump each year. To calculate the life extension factor of the systems we use table 2. The expected service life of this pump will be more than 14 years.

CURRENT MACHINE CLEANLINESS ISO 4406	LIFE EXTENSION FACTOR									
	2	3	4	5	6	7	8	9	10	
28/26/23	25/23/21	24/22/19	23/21/18	22/20/17	22/20/17	21/19/16	21/19/16	20/18/15	20/18/15	
27/25/22	25/23/19	23/21/19	22/20/17	21/19/16	21/19/15	20/18/15	20/18/14	19/17/14	19/17/14	
26/24/21	23/21/18	22/20/17	21/19/16	21/19/15	20/18/14	19/17/14	19/17/13	18/16/13	18/16/13	
25/23/20	22/20/17	21/19/16	20/18/15	19/17/14	19/17/13	18/16/13	18/16/12	17/15/12	17/15/11	
24/22/19	21/19/16	20/18/15	19/17/14	18/16/13	18/16/12	17/15/12	16/14/11	16/14/11	16/14/10	
23/21/18	20/18/15	19/17/14	18/16/13	17/15/12	17/15/11	16/14/11	16/14/10	15/13/10	15/13/10	
22/20/17	19/17/14	18/16/13	17/15/12	16/14/11	15/13/11	15/13/10	15/13/9	14/12/9	14/12/8	
21/19/16	18/16/13	17/15/12	16/14/11	15/13/10	16/13/9	14/12/9	14/12/8	13/11/8	13/11/8	
20/18/15	17/15/12	16/14/11	15/13/10	14/12/9	14/12/8	13/11/8	-	-		
19/17/14	16/14/11	15/13/10	14/12/9	14/12/8	13/11/8	-	-	-		
18/16/13	15/13/10	14/12/9	13/11/8	-	-	-	-	-		
17/15/12	14/12/9	13/11/8	-	-	-	-	-	-		
16/14/11	13/11/8	-	-	-	-	-	-	-		
15/13/10	13/11/8 ⁽¹⁾	-	-	-	-	-	-	-		
14/12/9	13/11/8 ⁽²⁾	-	-	-	-	-	-	-		
(1) Life Extension=1,8					(2) Life Extension Factor=1,45					

Table 2

Example

No. of machines:	20
Operating time:	5.000 hrs/year
Machine costs:	40 euro/hour
Labor costs:	35 euro/hour
Total downtime:	10.000 hours
Downtime caused by hydraulic failure:	35%

If we calculate total downtime costs without additional filtration:

Downtime caused by hydraulic failures	35% of 10.000 h	3.500 h
80% of all hydraulic failures caused by poor fluid conditions	0% of 3.500 h	2.800 h
Machine downtime costs	2.800 h * €40	€ 112.000
Labor costs for repairs	950 h * €35	€ 33.250
Total downtime costs	€ 112.000+€33.250	€ 145.250

By using RMF Systems filtration solutions we can prevent 80% of all poor fluid conditions related failures.

Superior filtration reduced downtime	80% of 2.800 h	2.240 h
Total poor fluid condition related downtime	2.800 h - 2.240 h	560 h
Machine downtime	560 h * €40	€ 22.400
Total downtime costs with superior filtration	€22.400 + €6.650	€ 29.050

This shows that you can save approximately **€ 116.200** each year by using additional filtration.



Maintenance

Maintenance

Equipment must be maintained to extend their service life and reduce the amount of downtime and failures.

Currently 'condition based maintenance' is an often heard term within the industry. RMF Systems prefers this approach to maintenance over reactive or preventive maintenance.

Reactive Maintenance

As the term suggests, reactive maintenance is an unplanned form of maintenance. Failures are solved when they occur, often causing unnecessary long downtime and high costs.

Preventive Maintenance

Preventive maintenance is a scheduled form of maintenance and therefore minimises downtime due to failures and interference with the system. The maintenance schedule is based on set specifications and standards for oil and component replacement. Unfortunately the service life of oil and components can't be predicted with complete certainty. Therefore preventive maintenance can lead to unnecessary high replacement costs or downtime.



Condition Based Maintenance

Condition based maintenance, also known as predictive maintenance, is based on constantly monitoring your equipment and analysing the data. The purpose of condition based maintenance is to find symptoms of potential failures before they occur. Real time data is collected by sensors within the system, enabling immediate action when required. Also this will lead to less frequent laboratory analysis, which saves costs.

Within condition based maintenance, we differentiate four types of analysis:

Oil quality analysis

Providing data on oil viscosity, acid levels, solid contamination, water content and oxidation level.

Vibration analysis

Determine issues like: bearing degradation, unbalanced components, structural support issues, rotational problems, alignment concerns, resonance and electrical problems.

Infrared analysis

Determine detrimental conditions such as: loose electrical connections, corrosion and dirt build up that induces high resistance joints, unbalanced electrical loads, and mechanical and process problems due to heat.

Stroboscopic analysis

Inspect wear on rotating equipment such as couplings and V-belts utilising a portable strobe light.

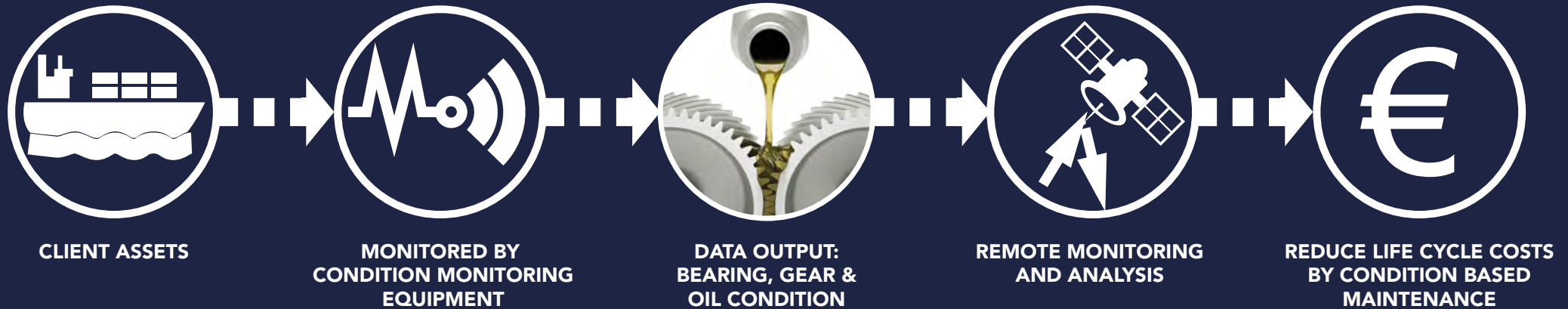





OFF-LINE FILTRATION



AIR BREATHING



BY-PASS FILTRATION



CONDITION MONITORING



DEHYDRATION

Solutions

Solutions

RMF Systems offers complete filtration and monitoring solutions for all types of equipment in practically every industry. The extensive RMF Systems range covers all kinds of contamination, whether it be solid, water, air borne or acids.

All solutions are focussed on:

- 1 Reducing malfunctions and downtime
- 2 Save (maintenance) costs
- 3 Extend service life of equipment and oil
- 4 Minimise oil and filter changes

RMF Systems can advise you on the optimal solution to solve your contamination problems. With our range of products we can find a fitting solution for your application.



Solutions for Solid Contamination

Most forms of solid contamination can be solved by utilising either an offline or bypass filtration system.

Bypass filtration

Bypass filtration units are especially suitable for mobile applications in hydraulic systems.

RMF Systems has designed a bypass filtration system that is equipped with an integrated pressure compensated flow control valve. This valve bleeds oil from the main system, passes this through the filter element before it returns to the reservoir. The amount of oil extracted from the main system at any time is insignificant ensuring that it will not affect the operation of the system.



Offline filtration

Offline filtration units can be applied to every imaginable industrial application where a hydraulic system is present. An integrated pump-motor combination pumps oil out of the reservoir, filters it and pumps clean oil back into the system. Offline filtration units can continue working even when the main system is not in use.



FACT

RMF Systems Depth filtration can remove contamination that is not removed by line filters.



Solutions for Water Contamination

Vacuum dehydration

The RMF Vacuum Dehydration Units are designated oil purification units which can be applied directly to various types of machine reservoirs. The units dehydrate and clean most types of oil such as lubricating, hydraulic, transformer and switch oils by removing particles, gasses, and water.

Water absorbing elements

The RMF cellulose elements have the ability to absorb water and filter particles down to 0,5 micron out of hydraulic fluids. Also special polymer spin-on filters and elements remove both water and solid particles.



Solutions for Contaminated Air

Air contamination can be prevented in multiple ways, one of them is the usage of desiccant breathers.

Desiccant breathers

RMF Systems' desiccant breathers deal effectively with both particle and water contamination in a single process. The air is dried by passage through a column packed with ZR gel granules. The dried air is subsequently filtered with the use of a pleated synthetic fibre filter element (replaceable spin-on type) that removes solid particles (down to 3μ). This process prevents contamination and oxidation of the oil and components.



Solutions for Acids

There are several ways to remove acids from oil. The obvious one is to use the alkalinity of oil to neutralise the acids. This is currently used method for removing acids in gas and diesel engine applications.

Acids formed by hydrolysis in ester based fluids are harmful to turbine control systems. The most common way to remove these acids is by using fuller earth or aluminium oxides or an ion exchange resin.

Electrostatic filter

This filter unit acts as a kidney loop filter. It pumps small amounts of hydraulic fluid through an electric field caused by 14000 volts in the cleaning cell. This electric field attracts and bundles particle to the surface of the cleaning element. The Electrostatic filter can remove solid particle down to 5 micron, sludge, varnish, resin and other oxidation products. The electrostatic oil cleaning has now influence to the liquid additives of the oil.



Acid-X

This filtration skid uses 3 Ion-exchange elements. The elements are specially designed for removal of oxidation products which are dissolved in the hydraulic fluid. These elements adsorb polar acids without adding nothing to the fluid such as conventional Ion exchange elements do by adding water to the system.



Condition Monitoring Solutions

Condition Monitoring Center (CMC)

The CMC provides you with reliable feedback on solid particle contamination, water levels (%RH), oil temperature and degradation. Making use of only high quality components and proven optical technology and algorithms, this CMC is the most accurate, consistent and advanced diagnostic monitoring centre. Its modular design and versatility make it the best condition monitoring centre for hydraulic and lubrication fluids, meeting the requirements of even the most demanding industries.



FACT

Visual examination of a fluid is not an accurate method of analysis.

Contamination Monitoring Sensor (CMS)

The CMS in-line particle counter automatically monitors and displays particulate contamination, moisture (%RH) and temperature levels in various hydraulic fluids. It is designed specifically to be mounted directly to systems, where ongoing measurement or analysis is required, and where space and costs are limited.



Oil Quality Sensor (OQS)

The Oil Quality Sensor provides real time oil deterioration data by continuously monitoring your hydraulic fluids. This OQS is a cost effective monitoring solution that enables you to base your fluid changes and maintenance on the actual condition of your fluids. Unnecessary and expensive oil changes belong to the past, which will result in significant cost savings.



Portable Laser Particle Counter (PLPC)

The PLPC is the most complete way to measure the contamination level of your system. With the PLPC you have the ability to measure, analyze and document your results immediately. The Portable Laser Particle Counter makes it possible to determine the ISO cleanliness levels of the hydraulic fluid. It can also report in any other international cleanliness level standards.



Moisture Content Sensor (MCS)

The MCS is a perfect solution for online monitoring of moisture in transformer, lubricating and hydraulic fluid, as well as diesel fuel. The MCS is perfectly suitable for long term usage in moisture levels, higher than 90% RH. Making it the perfect solution for gearboxes, thrusters and other applications where free water is a threat.

By combining the MCS with other RMF products like a Condition Monitoring Center and vacuum dehydration unit, we offer you the optimal solution for your water contamination problems.



Conversion Tools



Conversion Tools

Viscosity

cSt (at 100° F)	ISO-VG	SUS (SSU)
10	9	46
20	21	93
30	31	139
32	32	148
40	43	185
43	46	200
46	49	213
50	52	232
60	63	278
68	71	315
70		324
80		371
90		417
100	93	464
110		510
120		556
130		602
140		649
150	139	695

cSt: Centistokes

ISO: International Standards Organisation

SUS: Saybolt Universal Seconds (same as SSU)

SSU: (Saybolt Seconds Universal (same as SUS)

Comparison of Hydraulic Fluid Cleanliness Standards

ISO CODE	NAS CLASS
23/21/18	12
22/20/18	--
22/20/17	11
22/20/16	--
21/19/16	10
20/18/15	9
19/17/14	8
18/16/13	7
17/15/12	6
16/14/12	--
16/14/11	5
15/13/10	4
14/12/9	3
13/11/8	2
12/10/8	--
12/10/7	1
12/10/6	--

Pressure

FROM	TO	MULTIPLY BY
Atmosphere	Bar	1.01325
Bar	Atmosphere	0.9869233
Atmosphere	PSI	14.69595
PSI	Atmosphere	0.06804596
Bar	PSI	0.069
PSI	Bar	14.50
Bar	Pascal (Pa)	100000
Pascal (Pa)	Bar	0.00001
PSI	Pascal (Pa)	6894.747
Pascal (Pa)	PSI	0.000145

Volume

FROM	TO	MULTIPLY BY
Cubic Centimetres	Cubic Feet	0.00003521
Cubic Feet	Cubic Centimetres	28316.85
Cubic Centimetres	Cubic Inches	0.06102
Cubic Inches	Cubic Centimetres	16.38706
Cubic Centimetres	Litres	0.000001
Litres	Cubic Centimetres	1000
Cubic Centimetres	US Gallons	0.0002642
US Gallons	Cubic Centimetres	3785.412
Cubic Metres	Cubic Feet	35.310
Cubic Feet	Cubic Metres	0.02831685
Cubic Metres	Cubic Inches	61023
Cubic Inches	Cubic Metres	1.638706e-05
Cubic Metres	Litres	1000
Litres	Cubic Metres	0.001
Cubic Metres	US Gallons	264.20
Us Gallons	Cubic Metres	0.00378541
Litres	Cubic Centimeter	1000
Cubic Centimetres	Litres	0.001
Litres	Cubic Feet	0.035315
Cubic Feet	Litres	28.31685
Litres	Cubic Inches	61.0234
Cubic Inches	Litres	0.01638706
Litres	Gallons	0.220083
Gallons	Litres	4.544
Litres	US Gallons	0.264170
US Gallons	Litres	3.785
Litres/min	Cubic Centimetres/min	1000
Cubic Centimetres/min	Litres/min	0.001
Litres/min	Cubic feet/min	0.035
Cubic Feet/min	Litres/min	28.31685
Litres/min	Gallons/Min	0.264
Gallons/min	Litres/min	4.546092

Distance

FROM	TO	MULTIPLY BY
Centimetres	Feet	30.48
Feet	Centimetres	0.0328083
Centimetres	Inches	2.54
Inches	Centimetres	0.394
Metres	Feet	3.28083
Feet	Metres	0.3048
Metres	Inches	39.36996
Inches	Metres	0.0254
Metres	Yards	1.09361
Yards	Metres	0.9144
Microns	Inches	0.000039
Inches	Microns	25.400
Microns	Metre	0.000001
Metre	Microns	1000000
Microns	Millimetre	0.0001
Millimetre	Microns	1000
Millimetres	Feet	0.00328083
Feet	Millimetres	394.800
Millimetres	Inches	0.03937
Inches	Millimetres	25.40

Mass

FROM	TO	MULTIPLY BY
Grams	Pounds (lb)	0.0022046
Pounds (lb)	Grams	453.5924
Kilograms	Grams	1000
Grams	Kilograms	0.001
Kilograms	Pounds (lb)	2.20462
Pounds (lb)	Kilograms	0.4535924
Tonnes (t)	Tons (tn)	1.102311
Tons (tn)	Tonnes (t)	0.9071847

RMF Systems is committed to designing, manufacturing and supplying world leading, innovative solutions in the field of oil cleanliness and monitoring. Our goal is to maximise equipment availability and reliability in a wide range of markets by significantly improving oil cleanliness resulting in increased service life of oil and equipment.

The commitment to continuous research and development from our dedicated team of engineers has led to solutions that significantly reduce the total cost of ownership of equipment whilst benefiting the environment for future generations.

RMF Systems gladly helps you to determine the source of your contamination problem and informs you on the optimal solution to filter and monitor your oil.

Please contact one of our sales engineers for an appointment.

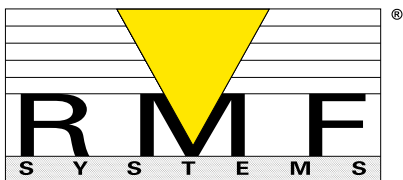

We're Here To Help You
Coenecoop 99 | 2741 PH
Waddinxveen | The Netherlands
T: (31) 182 30 26 06
E: info@rmfsystems.com
W: www.rmfsystems.com

