

LR
*Single-Stage
Horizontal*

LRV
*Single-Stage
Vertical*

LLR
*Two-Stage
Horizontal*

*Axially Split,
General Industry
Pumps*

Pump Supplier To The World

Flowserve is the driving force in the global industrial pump marketplace. No other pump company in the world has the depth or breadth of expertise in the successful application of pre-engineered, engineered, and special purpose pumps and systems.

Pumping Solutions

Flowserve is providing pumping solutions that permit customers to continuously improve productivity, profitability and pumping system reliability.

Market-Focused Customer Support

Product and industry specialists develop effective proposals and solutions directed toward market and customer preferences. They offer technical advice and assistance throughout each stage of the product life cycle, beginning with the inquiry.



Dynamic Technologies

Flowserve is without peer in the development and application of pump technology, including:

- Hydraulic engineering
- Mechanical design
- Materials science
- Intelligent pumping
- Manufacturing technology

Broad Product Lines

Flowserve offers a wide range of complementary pump types, from pre-engineered process pumps, to highly engineered and special purpose pumps and systems. Pumps are built to recognized global standards and customer specifications.

Pump designs include:

- Single-stage process
- Between bearing single-stage
- Between bearing multistage
- Vertical
- Submersible motor
- Positive displacement
- Nuclear
- Specialty

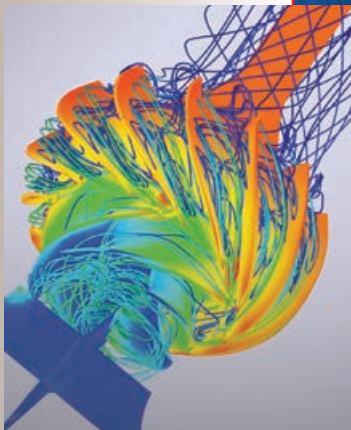
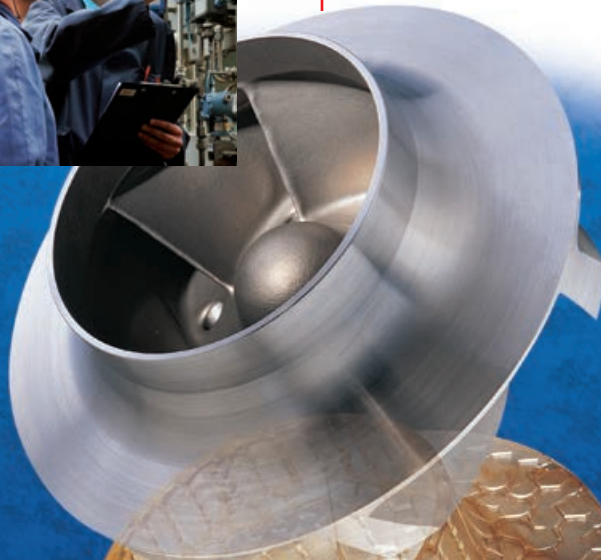

LR, LRV, LLR
Axially Split,
General Industry
Pumps

The Between Bearings Choice
for General Industrial Pumping

The single-stage LR and LRV and the two-stage LLR family of pumps are part of a broad range of axially split, heavy-duty, between bearings pumps. These pumps complement the similarly designed LNN and LNNV. Together these products offer 150 impeller-volute combinations, the industry's largest array of efficient hydraulic solutions.

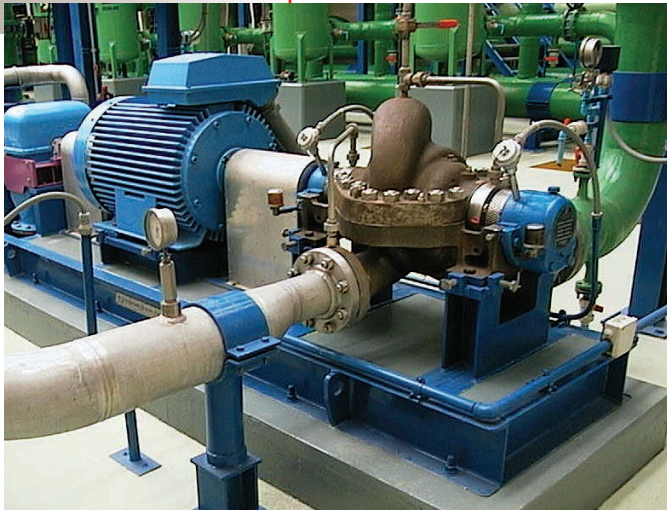

These time-tested pumps incorporate pre-engineered and packaged combinations of design features, as well as application-driven options which are superior to competitors' offerings. This leads to increased value in terms of lower maintenance requirements and higher efficiency.

Typical Industries Served

- Building trades
- Building services
- OEM
- Food and beverage
- Mining
- Steel
- Utility
- Pharmaceutical
- Water distribution
- Wastewater
- Agriculture
- Pulp and paper
- Rubber
- Petroleum

Complementary Pump Designs

Depending upon application requirements, Flowserve can also provide these pump designs:

- Vertical double-suction
- Vertical turbine
- High flow, axially split, double-suction
- End suction centrifugal

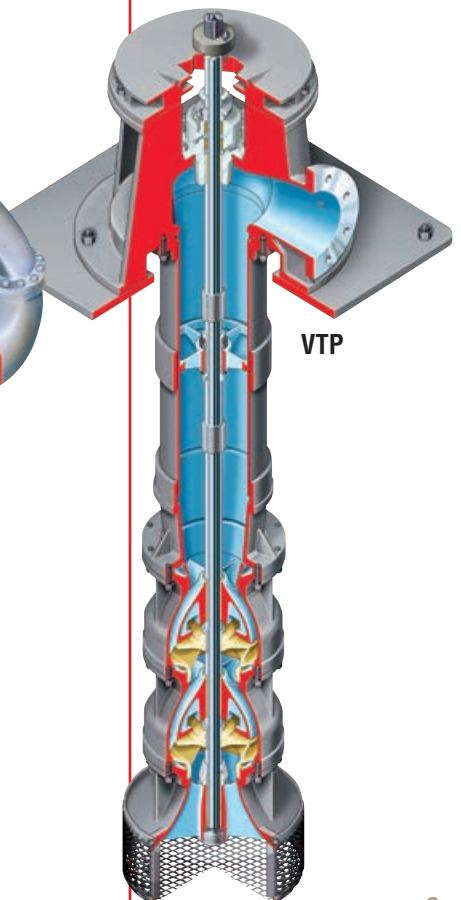
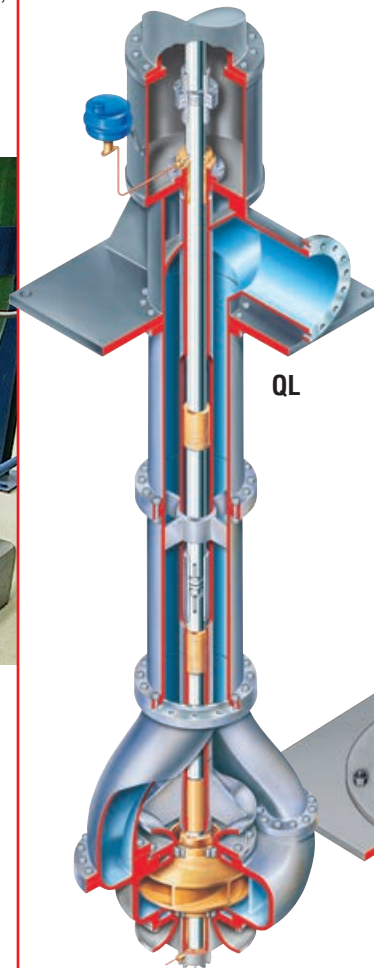
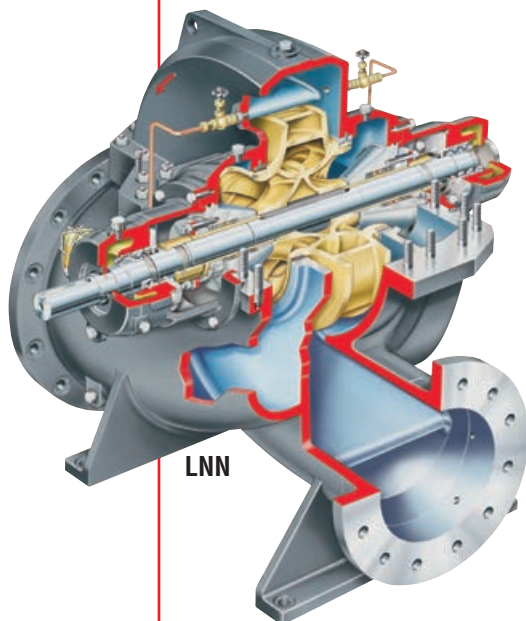

LR, LRV, LLR
Axially Split,
General Industry
Pumps

The LR, LRV and LLR family of pumps provides a broad range of hydraulic coverage and low total cost of ownership. With thousands of units installed over the years, these pumps provide reliable and efficient performance in applications ranging from water supply to circulation duties to petroleum distribution.

Designed for easy maintenance and maximum parts interchangeability, the superior engineering and construction of these pumps result in reduced downtime and minimized parts inventory for users.

- Rugged, heavy-duty construction
- Superior design features
- Low initial investment
- High efficiency

LR (29 Sizes)
Operating Parameters

- Standard flows to 2000 m³/h (8800 US gpm)
- Heads to 170 m (560 ft)
- Pressures to 21 bar (300 psi)
- Temperatures from -30°C (-20°F) to 150°C (300°F)

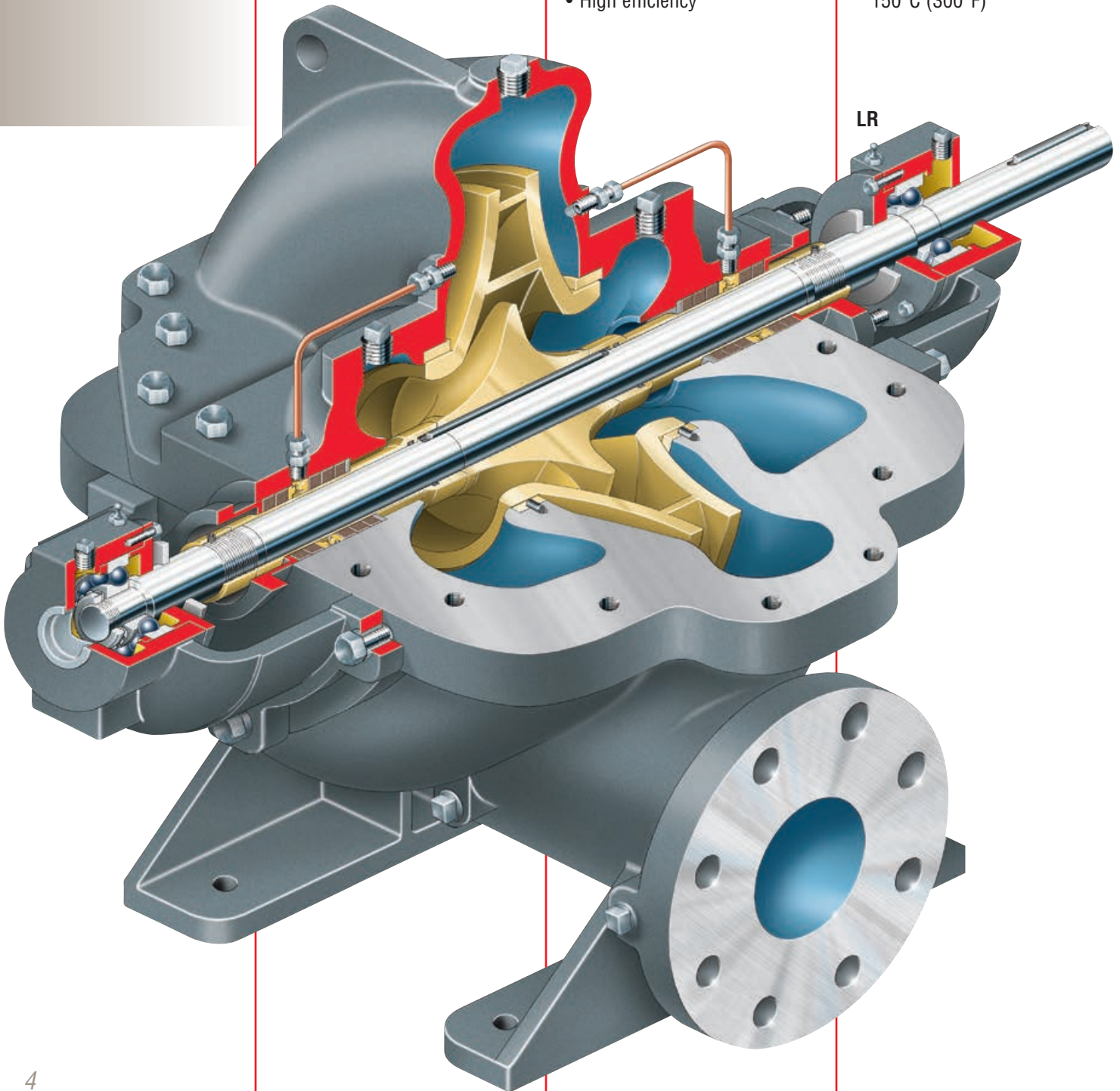

Split Case Design with lifting lugs simplifies maintenance by allowing access to the rotating element without disturbing the piping or driver.

Low NPSH Enclosed Impellers provide high efficiency and optimum performance over a wide flow range. Most LR and LRV models feature double-suction impellers. The LLR incorporates back-to-back, single-suction impellers.

Radial and Thrust Bearings are available with oil or grease lubrication. Designs include single row, deep groove ball bearings or duplex thrust ball bearings. Typical L10 bearing life is 100 000 hours.

Heat-treated Steel Shaft limits deflection to 0.05 mm (0.002 in), prolonging seal life.

Shaft Sleeves are secured by external nuts and include O-rings to ensure reliable internal sealing.

Mounting Feet transmit pipe strain loads to the base and foundation, extending bearing life.

Dowel Bushing maintains concentricity between the bearing bracket and the casing.

Ease of Maintenance Features

- Replaceable seal chamber bushings maintain proper packing and lantern ring location.
- Shaft sleeve nuts lock impeller and shaft sleeve in position.
- Short distance between bearings reduces shaft deflection and resultant wear to components.
- Removable bearing brackets allow bearing maintenance without disturbing upper casing.
- Rectangular cross-section gland packing permits quick and easy replacement.
- Optional component and cartridge mechanical seals provide leak-free operation.
- A range of corrosion-resistant materials reduces maintenance costs.

Standard Case Wear Rings

allow economical renewal of operating clearances. Special serrated groove designs are available.

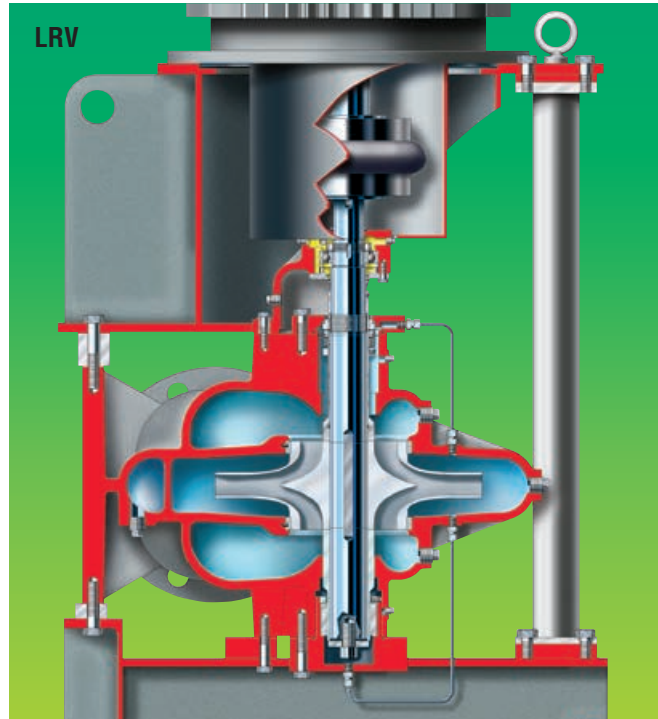

LRV Vertical Shaft Design

- Small footprint reduces floor space requirement.
- Parts are interchangeable with LR design.
- Maintenance-free, product-lubricated bottom bearing eliminates the need for mechanical seal and ball bearing.

LRV (20 Sizes) Operating Parameters

- Flows to 2000 m³/h (8800 US gpm)
- Heads to 137 m (450 ft)
- Pressures to 21 bar (300 psi)
- Temperatures from -30°C (-20°F) to 150°C (300°F)

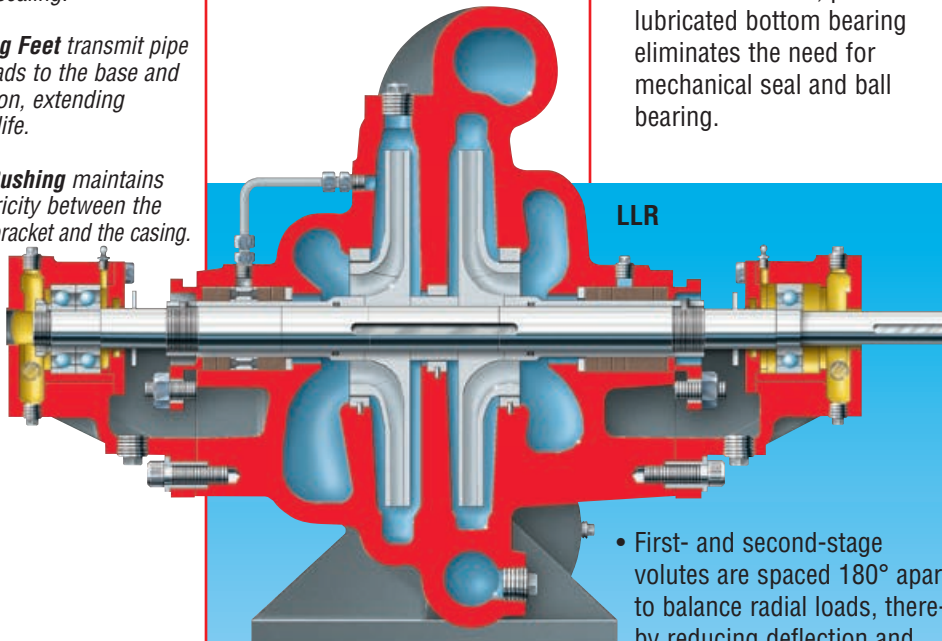

LLR Two-Stage Design for High Head Applications

- Back-to-back mounted, single-suction impellers reduce axial thrust, prolonging bearing life.

LLR

- First- and second-stage volutes are spaced 180° apart to balance radial loads, thereby reducing deflection and prolonging bearing life.
- Crossover cast-in upper casing half provides the rigidity necessary for high-pressure applications.

LLR (Six Sizes) Operating Parameters

- Flows to 295 m³/h (1300 US gpm)
- Heads to 290 m (950 ft)
- Pressures to 31 bar (450 psi)
- Temperatures from -30°C (-20°F) to 150°C (300°F)

- Interstage bushing minimizes interstage leaking and maximizes efficiency.
- Back-to-back mounted duplex angular contact bearing carries thrust.

Options and Technical Data

Shaft Sealing

The seal chamber design readily accommodates component or cartridge type mechanical seals and graphite impregnated non-asbestos packing with a lantern ring. The user can choose or convert to the sealing option most appropriate to the service.

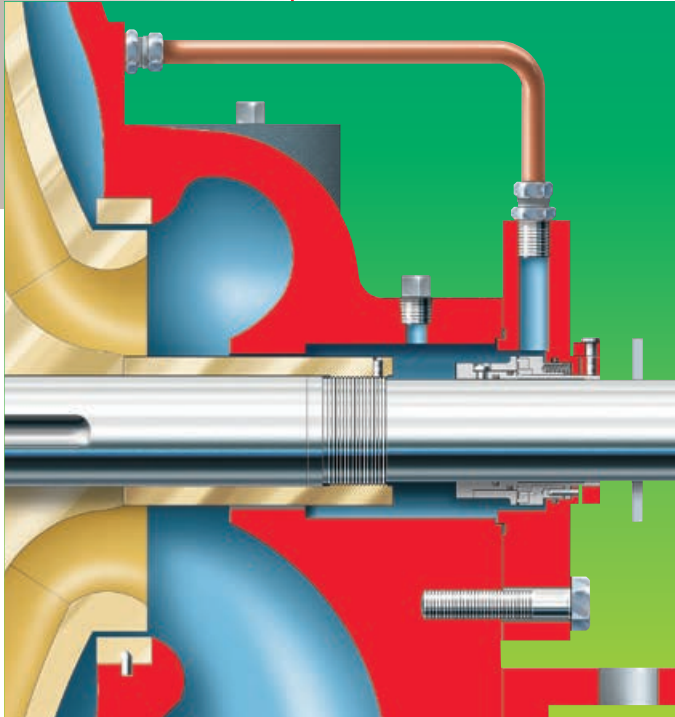

Optional Casing Materials

Erosion- and corrosion-resistant materials are available to suit service conditions.

- Cast iron
- Ductile iron
- Ductile Ni-Resist D2
- Bronze
- Nickel aluminum bronze
- Carbon steel
- 316 stainless steel
- Duplex stainless steel

Flange Designs

Suction and discharge flanges are available in flat or raised face and to the following standards:

- ASME (ANSI)
- DIN
- ISO

Baseplate Options

- Channel steel
- Folded steel
- Folded steel with drip rim
- Raised rim with grout holes

Optional Impeller Wear Rings

Impeller wear rings are available as an option or may be retrofitted by re-machining the impeller.

High Performance Coatings

Performance-enhancing coatings may be applied to internal casing surfaces to maximize pump efficiency. Corrosion- and erosion-resistant coatings also are available.

Extended Motor Mount

LRV vertical pumps are available with intermediate shafting that enables the motor to be mounted at a high level, avoiding potential flooding.

LR-LRV-LLR Range Chart

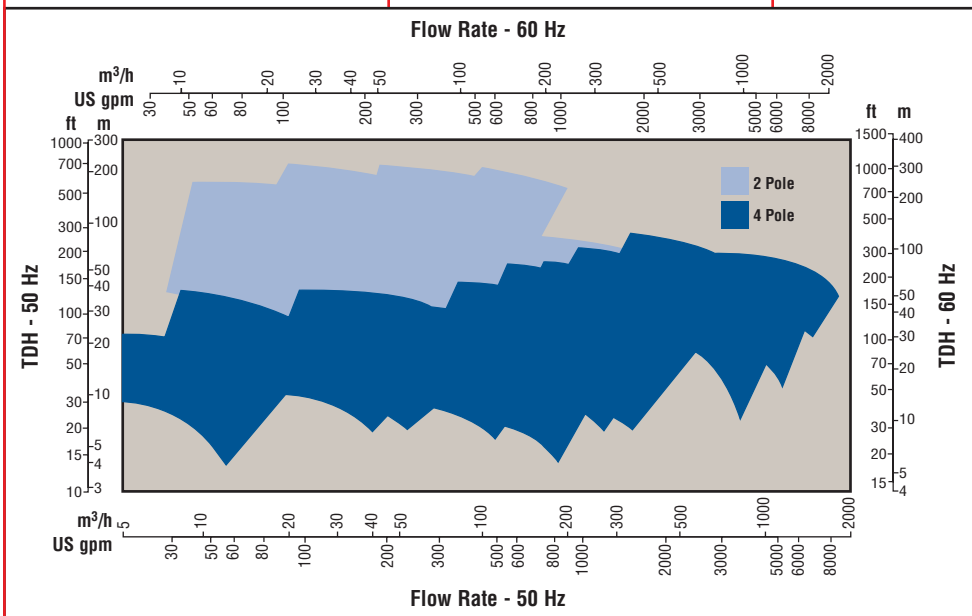

**Global
Engineered Services
and Support**

- Total Cost Reduction*
- Asset Management*
- Product Life Cycle*
- Performance Re-rates*
- Site Diagnostics*
- Repair Services*
- Energy Management*
- Spare Parts*
- Maintenance Contracts*
- Materials Upgrades*
- Turnkey Services*
- Field Repairs*
- Installation*
- Project Supervision*
- Commissioning*
- Equipment Upgrades*
- Condition Monitoring*
- Systems Analysis*
- Field Machining*

Service Dedication

Flowserve Engineered Services is focused on providing customers with uncompromising service and support, where and when needed. Dedicated to delivering the highest quality support, Engineered Services integrates its extensive pump and materials engineering knowledge with creative service solutions. Engineered Services fully understands the business challenges facing customers and is prepared to manage solutions to succeed as a team.

A worldwide network of service and repair centers staffed by highly skilled engineers and technicians is available around the clock, seven days a week to respond to customer queries, evaluate and troubleshoot problems and provide reliable solutions.



**Strength of Experience,
Commitment to Excellence**

Flowserve has long served industries requiring superior equipment performance and service life.

- Oil and gas production
- Hydrocarbon processing
- Chemical processing
- Water resources
- Power generation
- Nuclear
- Mining and mineral processing
- Pulp and paper
- General industry

Engineered Services is dedicated to maximizing equipment performance and providing reliability-centered maintenance programs for pumps and related equipment, regardless of manufacturer. Using the FlowStar™ asset management software, Engineered Services tracks performance and supports improvement programs using a service life cycle cost business approach. The results are improved reliability and increased profitability.

Business Partner

Flowserve partners with customers to respond to the dynamic business conditions that affect them. Flowserve will work with customers to drive efficiency, maximize throughput and control process quality. Whether user needs involve on-site technical assistance or broader project planning with full turnkey responsibility, Flowserve Engineered Services will deliver professional, reliable results.

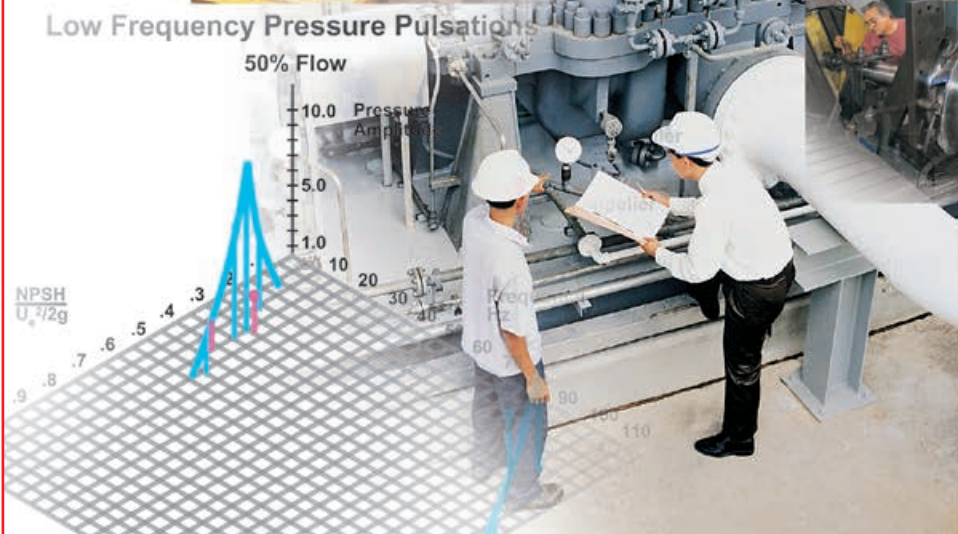

**Flowserve... Supporting Our Customers
With The World's Leading
Pump Brands**



Cameron™

Pleuger®

Durco®

Niigata Worthington™

Scienco™

TKL™

IDP®

Pacific®

HALBERG™

Worthington Simpson™

Calder™ Energy Recovery Devices

Flowserve®

Byron Jackson®

SIHI®

Lawrence Pumps®

Worthington®

Sier-Bath®

United Centrifugal®

Western Land Roller™

INNOMAG®

Wilson-Snyder®

Aldrich™

ACEC™

USA and Canada

Flowserve Corporation
5215 North O'Connor Blvd.
Suite 2300
Irving, Texas 75039-5421 USA
Telephone: +1 937 890 5839

Europe, Middle East, Africa

Flowserve Corporation
Parallelweg 13
4878 AH Etten-Leur
The Netherlands
Telephone: +31 76 502 8100



Latin America

Flowserve Corporation
Martín Rodríguez 4460
B1644CGN-Victoria-San Fernando
Buenos Aires, Argentina
Telephone: +54 11 4006 8700
Telefax: +54 11 4714 1610

Asia Pacific

Flowserve Pte. Ltd.
10 Tuas Loop
Singapore 637345
Telephone: +65 6771 0600
Telefax: +65 6862 2329

Your local Flowserve representative:

**To find your local Flowserve representative,
please use the Sales Support Locator System
found at www.flowserve.com
or call: +1 937 890 5839.**