



Atlas Copco



Atlas Copco

GHS 900 VSD+

VACUUM PUMP



GHS 350-900 VSD⁺

Industry 4.0 oil-sealed screw vacuum pumps
with HEX@™ connectivity and control



GHS VSD⁺ with HEX@™:

A game changer

Clean. Silent. Energy efficient and now with HEX@™ - next generation connectivity. Our GHS VSD⁺ range of intelligent vacuum pumps with Variable Speed Drive (VSD) technology have taken a leap ahead and raised the game with HEX@™ - an innovative new pump controller that gets you in gear for Industry 4.0.



Innovative, intelligent vacuum pumps

The GHS 350-900 VSD⁺ Series is a range of connected, intelligent, oil-sealed rotary screw vacuum pumps with Variable Speed Drive (VSD) technology. Based on the well-known and durable plug-and-play design principles, these vacuum pumps have been designed by vacuum engineers to deliver peak performance at your operating pressure.

These unique products offer:

- Increased efficiency – State-of-the-art screw technology, Variable Speed Drive (VSD) and innovative motor design combine to produce a leap forward in efficiency
- Quiet operation – Noise level is far below that of comparable technologies
- Sustainable productivity thanks to built-in efficiency
- Reduced environmental impact due to ultra-high oil retention at all operating pressures



Perfect for diverse markets

The GHS VSD⁺ Series vacuum pumps are ideal for a range of applications in plastics, glass, bottling, canning, wood, packaging, printing and paper, meat packaging and many more. The GHS 350-900 VSD⁺ is an optimal solution when a dedicated pump is required in the production area.

Low lifecycle costs

- **For replacement pumps**, the GHS VSD⁺ Series offers a very low lifecycle cost (including service activities and energy). Generally the payback time against existing oil-lubricated or multiple dry vane installations will be much less than two years, considering energy consumption and maintenance costs alone, without taking into account the ease of installation.

Benefits for your vacuum installation

With these vacuum pumps you can potentially save 50%* or more in energy costs. They are among the most energy-efficient oil-lubricated vacuum pumps on the market in the capacity range where some other technologies (e.g. oil-sealed vane) start to become mechanically inefficient and expensive in terms of capital expenditure.

*In most applications compared to traditional fixed speed vacuum technologies based on measurement with our Vbox energy audit tool.

Outlet

Inlet



Long-lasting components

The oil separator is designed for highly efficient oil coalescing with ultra-low back pressure, which means less energy consumption. This contributes to a long oil separator life that is double that of a comparable oil-sealed vane vacuum pump. Another contribution to oil separator life is the patented design which never allows the filtration media to be overloaded, so they last much longer. This is great news for your maintenance budget.



Easy, fast installation saves time

- Space-saving – The GHS VSD+ Series has one of the smallest footprints on the market
- Everything you need is delivered in a single and neat enclosure
- Plug-and-play installation
- Multiple pumps can be controlled by the HEX@GRID



Optimized working surroundings

In addition, the GHS VSD+ Series offers a very low noise level when compared to other vacuum pumps on the market today. Its market-leading oil retention also means that the quality of the exhausted air is optimal and oil spills on the factory floor are avoided. The end result is a significantly cleaner working environment.



Guaranteed uptime and low costs

The GHS VSD+ Series is designed for easy and infrequent maintenance: Mean Time Between Maintenance (MTBM) rates are extremely long. No water is needed, and HEX@™ is available to keep you effortlessly informed of pump performance and maintenance requirements.

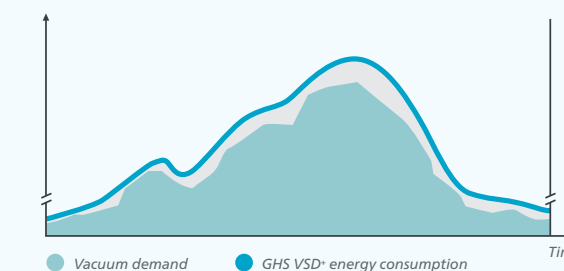
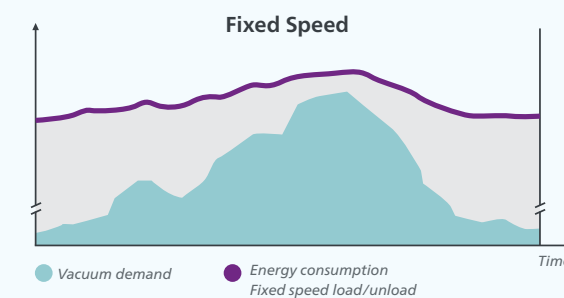

*In most applications compared to traditional fixed speed vacuum technologies based on measurement with our Vbox energy audit tool.

Energy savings

VSD and set-point control – not normally features of vacuum pumps – lead to significant energy savings. Set-point control allows you to optimize the energy you use to maintain your process vacuum level and thereby optimize your process efficiency and performance. The lowest possible flow will be delivered to match your required vacuum level or speed – nothing is wasted!

Humid version

A unique water handling capability provides you with the versatility and flexibility you need.

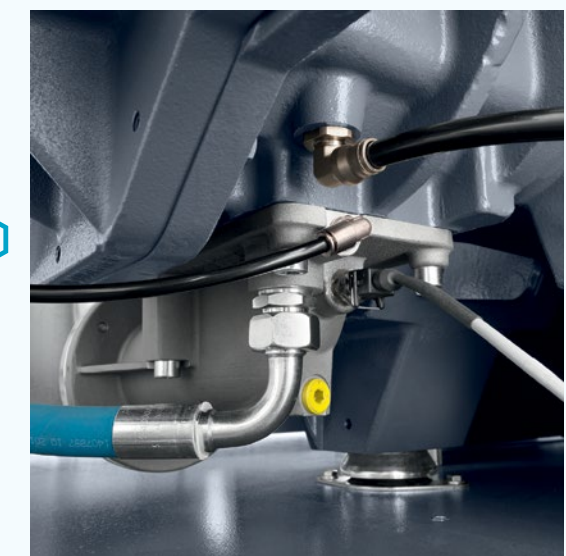

The innovative technology that makes it work



Element

- Highly efficient oil-sealed rotary screw
- Outstanding performance in a robust design
- Element life is significantly longer than screw compressors and vane pumps



Inlet control valve

- Modulating vacuum control in conjunction with the VSD drive to minimize energy consumption

Guaranteed oil retention

- Optimum design for maximum oil retention
- Longer life due to managed performance: the vacuum pump never overloads the separators
- Innovative and patented oil separator design retains oil at $<3 \text{ mg/m}^3$ even under the high loads



Easy to use, simple to maintain

- The top cover of the oil separator has a unique hinge mechanism. It slips the cover to the side, allowing the oil separator filter to be changed easily and quickly
- A cleverly designed exhaust pipe (drip drain leg) enables the condensate to be collected in the discharge pipework at the outlet and can be drained via the outside of the canopy

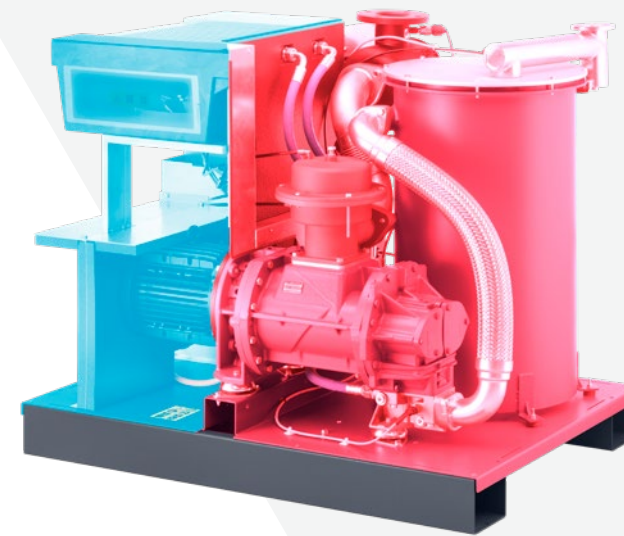

Canopy with hot-cool zones

The GHS VSD+ Series features a canopy with a hot-cool design. It isolates all heat producing and temperature critical components (oil separator and element) from all other components. As cool running means higher reliability, this feature extends the lifetime of electronic components and leads to a longer Mean Time Between Maintenance (MTBM).



HEX@™ monitoring system

HEX@™ is a state-of-the-art monitoring system for your vacuum pumps. It is simple and comprehensive, and leads to energy savings. It can also integrate your plant management system thanks to a remote monitoring option.

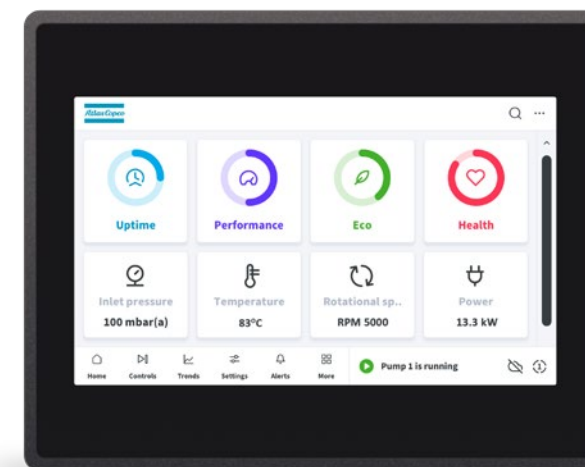

VSD+ for potential energy savings of 50%* or more

In almost every production environment, the need for vacuum fluctuates depending on different factors such as process changes, the time of day, week or even month. Extensive measurements and studies of demand profiles show that there are many substantial variants with regards to vacuum demand.

Why Atlas Copco variable speed drive technology?

- Potential energy savings of 50%* or more with an extensive flow range (10-100%)
- Reduced electrical installation costs (fuse and cable size)
- Integrated HEX@™ graphic controller controls the motor speed and high efficiency frequency inverter
- Eliminates peak current penalty during start-up experienced with stop-start machines

Energy savings*

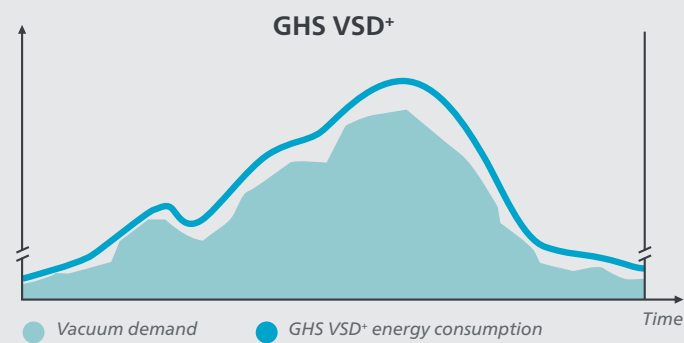
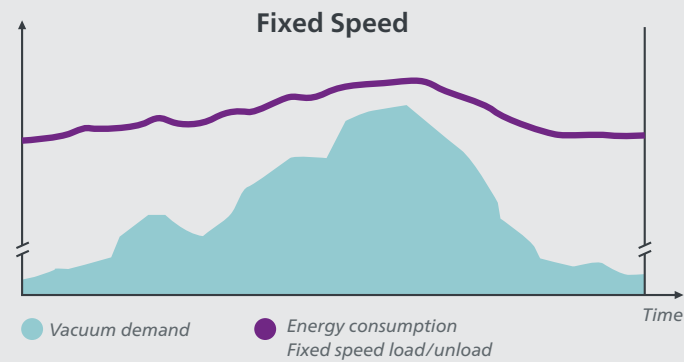

*In most applications compared to traditional fixed speed vacuum technologies based on measurement with our Vbox energy audit tool.



Fixed Speed Vacuum Pump



50%*
SAVINGS



GHS VSD+

● Energy ● Investment ● Maintenance



: Sixth sense intelligence through connectivity and control

With HEX@ you can **monitor and control** your pump from anywhere and at any time. You can receive feedback and review pump operating status, vacuum levels and upcoming scheduled events for your vacuum system.

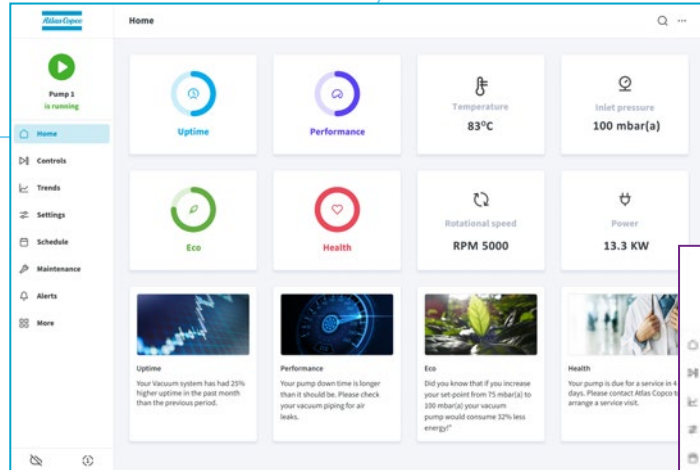

Screens showing KPIs for process optimization



Access and visualize pump trends, such as pressure and temperature



User-friendly interface options (above and right) by which to access HEX@'s functionalities

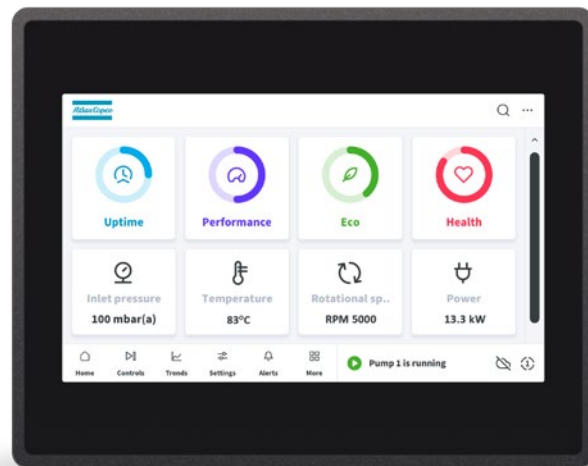

Automated insights and updates

HEX@ offers the benefits of having a connected device such as automatic software updates, access to future released functionality and increased understanding into vacuum performance. HEX@ will also provide insights, recommendations and feedback based on pump performance both current and historically. Perhaps the energy efficiency of the vacuum pump can be improved, or your maintenance interval can be extended? HEX@ will empower you to take proactive steps to optimize your vacuum system and maximize your production.

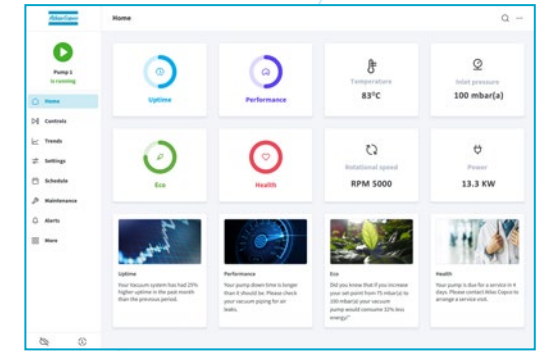

Configurable interface

With clear presentation and intuitive layout, the HEX@ ergonomic interface is quick and straightforward to navigate. Unlike traditional control interfaces, HEX@ allows you to configure parts of the home screen to display the information that is most important and relevant to you.

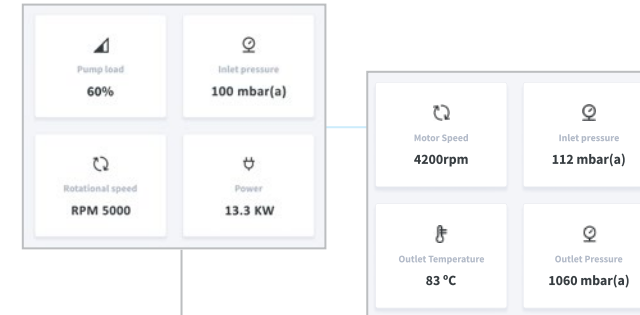

Secure web-based interface

This is possible by accessing your secure, web-based user interface to connect directly to your pump (or fleet of pumps). From your web-enabled device, PCs, laptops, tablets or smartphones, you can control and monitor your pump like you were standing right next to it.

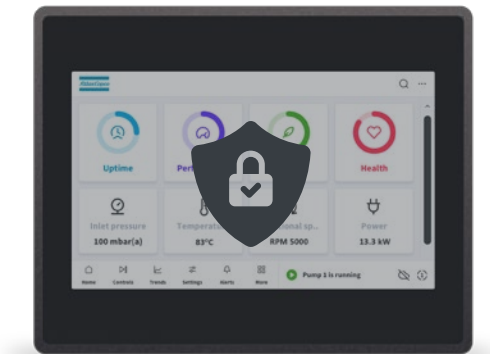

Smart functionalities

HEX@ also has smart functionalities which let you, for example, plan specific functions outside the production time – this can be set either on calendar day or running hours. You can also switch between operating modes which means you can save your operation settings for future convenience, moving between setting profiles according to the needs of production.

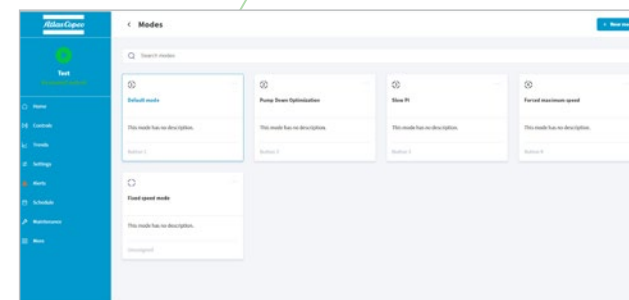

Applications

The GHS VSD+ Series is suitable for a range of applications in various industries. The capacity range of these pumps means they are ideal for central systems or larger installations. Here are some of the key ones.

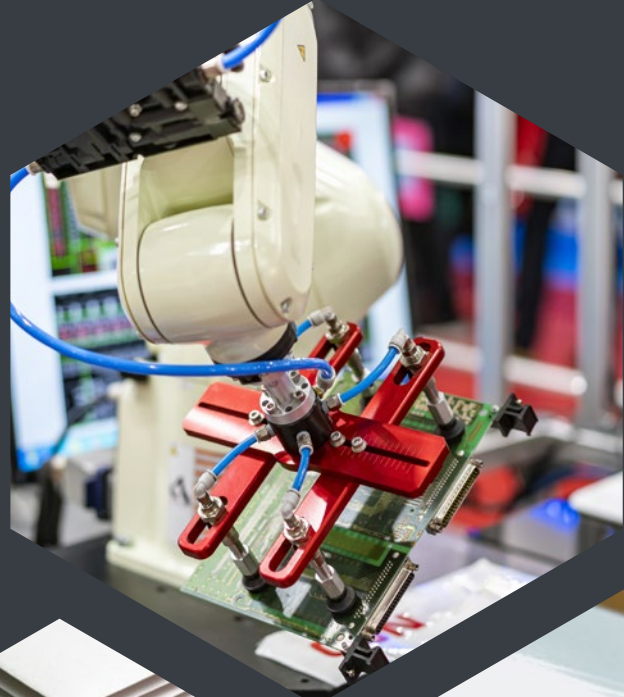

Holding, lifting and moving applications:

- Pick and place – especially electronics
- Envelope manufacture
- General packaging
- Woodworking

Forming and shaping applications:

- Plastics (e.g. bath tubs, shower trays, white goods internals)
- Packaging materials (e.g. thermoformed parts)
- Glass items such as bottles and windscreens
- Wood/lamination



Preserving applications:

- Meat packaging (flat, vacuum packs, controlled atmosphere packaging)
- Poultry packaging
- Modified atmosphere packaging (gas flushing)
- Canning

Humid applications:

- Roof tile and brick manufacture
- Pipeline drying
- Salad cooling

When a clean environment is essential:

- Heat treatment, nitriding and metallurgy
- Altitude simulation
- Drying and general evacuation duties
- Coating
- And many more...



Numerous configurations to match your application

Choose the version that matches your specific application requirements:



Standard

This machine focuses on delivering the exact performance you demand, at the lowest possible lifecycle cost. Ideal for applications where you need to maintain a set vacuum level (set point).



Humid

Suitable for high water content duties, for applications such as plastics, clay molding, drying pipelines, salad cooling, freeze drying, etc.

Configuration for high water vapor tolerance constitutes the humid version.



Pumpdown Optimization

This fast evacuation version enables faster cycle times – meaning more production. It's ideal for meat, cheese and chicken packaging, as well as cooling, freeze drying and general vessel evacuation applications.



Technical specifications

Model	Ultimate pressure		Frequency range	Average absorbed power at minimal speed		Nominal motor rating		Noise level range	Oil capacity		
	mbar(a)	torr		kW	HP	kW	HP		L	Gal	
GHS 350 VSD*	0.35	0.26	20 - 116	1.5	4.7	5.50	7.4	51-65	16	4.23	
GHS 585 VSD*			20 - 150			7.5	10				51-68
GHS 730 VSD*			29 - 200			11	14.8				51-73
GHS 900 VSD*			20 - 233			15	20				51-76

ISO21360-2:2012
 Electrical specification: 380/460V 50/60Hz IP54 cubicle CSA/UL.
 220 V/575 V: available upon request.
 Available oils include mineral, synthetic and food grade.

Dimensions and weight



Dimensions	Gas inlet	Gas outlet	Length		Width		Height		Weight	
			mm	in	mm	in	mm	in	kg	lb
GHS 350 VSD*	DN80	DN60	1266	49.8	934	36.8	1083	42.6	495	1091
GHS 585 VSD*									500	1102
GHS 730 VSD*									510	1124
GHS 900 VSD*									520	1146

Performance curves

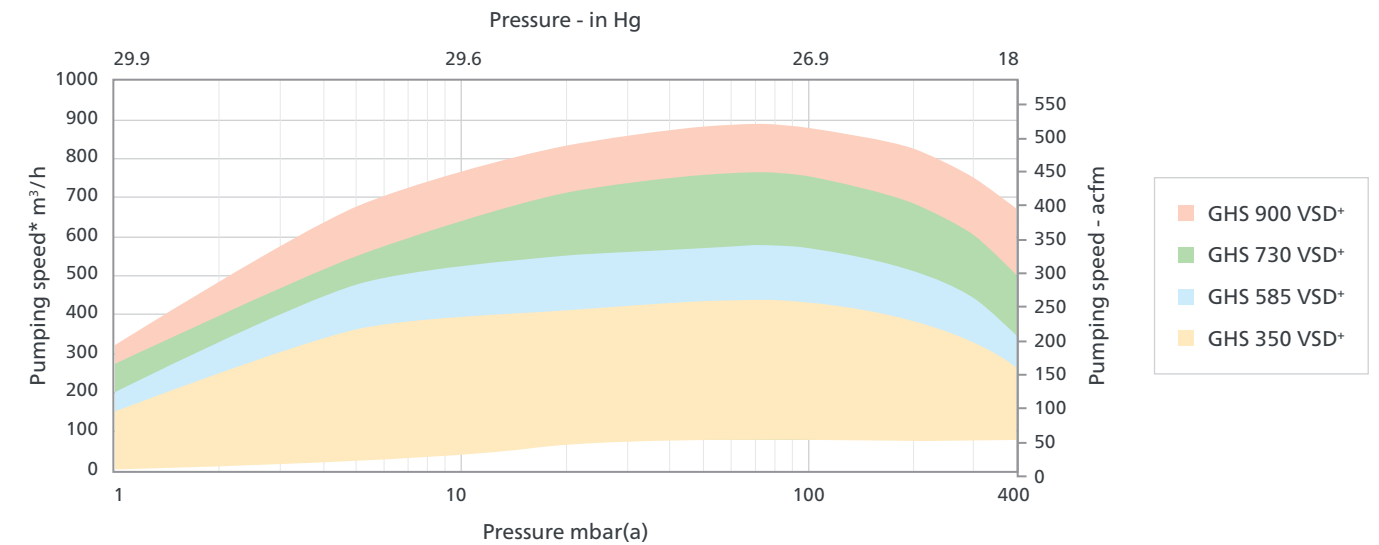

*Pumping speed at element inlet at steady state - according ISO 21360-1:2012 (E).

Service solutions

Preventive Care



Complete service with our Preventive Care plan

We take over the maintenance planning and responsibility for servicing your vacuum pump on a regular basis. Our Preventive Care plan is tailored to your pump's needs. As your pump is serviced with the latest technology, high levels of energy efficiency are achieved. We will also optimize service events to reduce your total cost of ownership and increase your productivity. This allows you to focus fully on your production.



Maximize lifetime of your vacuum pumps

Our vacuum specialists are well trained and experts in the field. They will help you to improve uptime and protect your processes. Regular maintenance conducted by one of our vacuum specialists reduces the risk of deterioration. Damaged or worn parts will be replaced with genuine Atlas Copco spare parts to protect your investment and increase the lifespan of your vacuum pumps.



Cost-effective approach

Regular scheduled maintenance can identify potential problems before they occur and plans can be structured around your individual production situation. Preventive Care enables cost management as you can plan your maintenance costs in advance. In this way, expenses associated with unplanned downtime are minimized.



Reliability meets non-stop productivity

We use genuine Atlas Copco spare parts and oil and our services are conducted by vacuum specialists according to manufacturer's recommendations. This enhances your vacuum pump performance, reducing the risk of downtime and enabling your production to run more smoothly.



atlascopco.com

