



Vorwald-  
akselinkäsittelylaitteet



Pneumatic expansion shafts



Mechanical expansion shafts



Expansion couplings



Expansion chucks and adapters



Friction and knife shafts

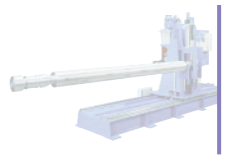

Shaft handling

# Shaft handling

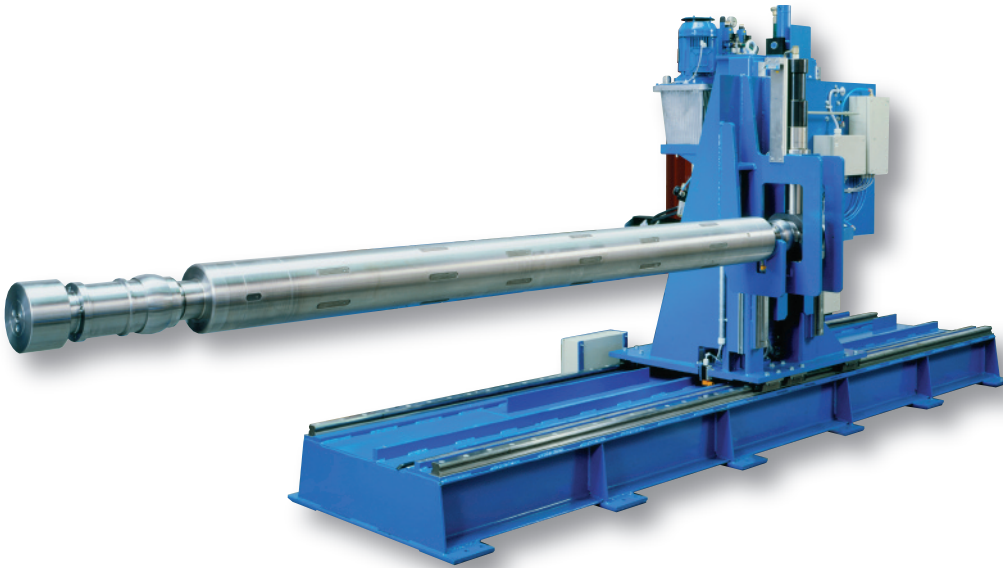

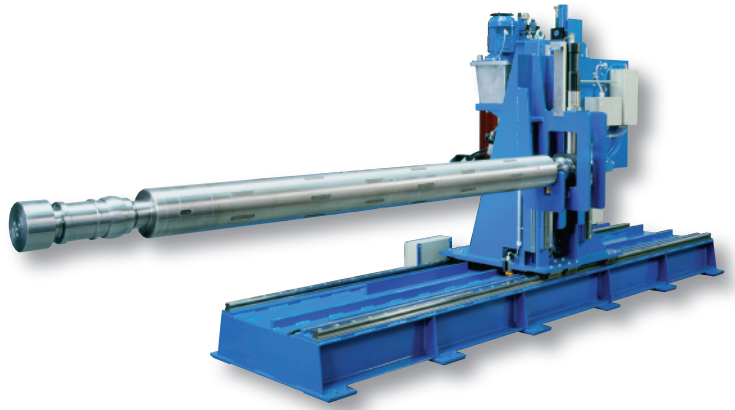

Pneumatic expansion shafts



Mechanical expansion shafts



Expansion couplings



Expansion chucks and adapters



Friction and knife shafts

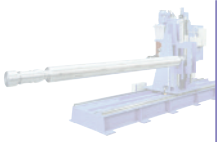

Shaft handling

|     |   | Page |
|-----|---|------|
| 6   | Shaft handling                            | 4    |
| 6.1 | Inquiry data sheet, constructional form 1 | 6    |
| 6.2 | Inquiry data sheet, constructional form 2 | 7    |

# We want you to be successful

The expansion units presented in this catalogue originate from the Vorwald Classic Programme and the winding technology products developed and marketed by Deublin USA and Germany. By virtue of their specific features these products have acquired a large market share in the field of rewinding and unwinding systems in the paper and film processing industry ranging from the smallest to the largest installations. The sheer breadth of products within the Neuenhauser-Vorwald range means that all areas of winding technology are now covered. Each product reflects the quality and experience of the manufacturing company behind it. Neuenhauser-Vorwald manufactures these products in European factories that are equipped with ultra-modern facilities and have been **certified according to DIN ISO 9001**. Our product quality and depth of experience ensures for all our customers economic utilisation of our expansion units.



# Shaft handling

## Expansion shaft pullers for Vorwald shafts and other brands

Vorwald shaft pullers (EA) are utilised in numerous different versions in all branches of the paper, plastic, metal foil and laminate materials processing industries. Constantly increasing reel weights and dimensions, automated production sequences and stricter regulations regarding work safety have led to the increasing replacement of manual handling of expansion shafts by automated shaft pullers. Shaft handling devices serve for pulling the expansion shafts out of the finished reel and for introducing them into the core. Further functions such as automated core loading from the core magazine or pick up and removal transportation of the finished reel, are available and can be included as one complete turn-key package.

### Features and advantages

- Many years of experience in handling expansion shafts
- The modular design system permits adaptation to actual requirements, from handling a small 50 kg expansion shafts to the shaft weighing many tons for a paper machine
- Gentle hydraulic expansion of the shaft journals, with support when required
- Automated venting of the expansion shaft
- Hydraulic lifting stroke with overload protection function protects the expansion shaft journals against deformation
- Vertical axis with roller rail system without play permits absolutely horizontal pull-out and feed-in of the expansion shafts
- Continuous jolt-free accelerations protect the expansion shaft and reduce machine wear
- Easy operator controls manually/semi-automatically/fully automated, adapted to the customer requirements
- Interface adaptation to the existing machine is possible by incorporating a PLC
- Economically efficient by virtue of short reproducible working cycles
- Utilisation of proven brand components for hydraulics, drive and roller rail system ensures many years of economic and reliable operation
- Complete planning, production, and assembly to customer acceptance test on own premises
- Production complying with DIN ISO 9001
- Best service and quick parts availability through the powerful Neuenhauser organisation

Mobile clamping shaft puller



## Constructional forms

The two standard constructional forms described below are offered for the expansion shaft handling system using the cantilever principle.

### 1. Travelling machine

Consisting of a machine bed with linear guides. A travelling machine stand is mounted on this machine bed. A clamping shaft take up plate is attached to the stand. When the finished reel has been put aside, the stand moves towards the expansion shaft, clamps the shaft journal and pulls out the expansion shaft continuously without jolts.

The height adaptation can take place from the shaft puller or from the reel depositing table. After the reel has been transported away (e.g. with a prism trolley), the shaft is equipped with a new core and the shaft puller then returns the expansion shaft in front of the machine or into the shaft magazine.

The chief feature of this version is that the shaft puller performs the clamping function and the travel movement.

### 2. Stationary version

Consisting of a stationary machine stand with expansion shaft take-up plate. The finished reel is deposited on a prism trolley in front of the shaft puller.

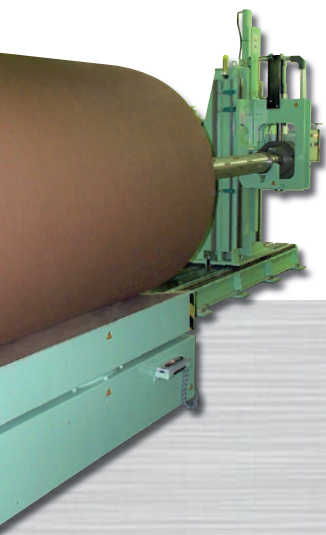

Expansion shaft puller with turnable prism trolley

The height adaptation is performed either by the shaft puller or by the prism lifting trolley. The shaft puller performs only the expansion shaft holding function. The shaft is pulled out by the reel trolley driven by an electric motor. The choice between versions will depend on which is the most economic solution in all the circumstances of each case. Which one of the two versions brings the economically most efficient result must be decided individually for each project. The best solution is often dictated by the available space or by the material flow of the finished reel.

### 3. Special version

In special cases or in the case of very heavy expansion shaft weights we can also offer a machine deviating from the standard solutions described here.

Please inquire. We are pleased to assist you with advice and service already in your project planning phase.

## Options for Vorwald Shaft Pullers

- Semi-automatic or fully automated operation with PLC
- Take up plate for customised expansion shafts
- Take up plate for two expansion shafts (aluminium separator)
- Prism lifting table with or without travel system

## System supplementations

- Automatic reel feed
- Automatic core magazine
- Automatic shaft take over facility
- Automatic prism lifting table/prism under floor trolley with running gear and reel ejection device

## Travelling Shaft Puller Constructional form 1

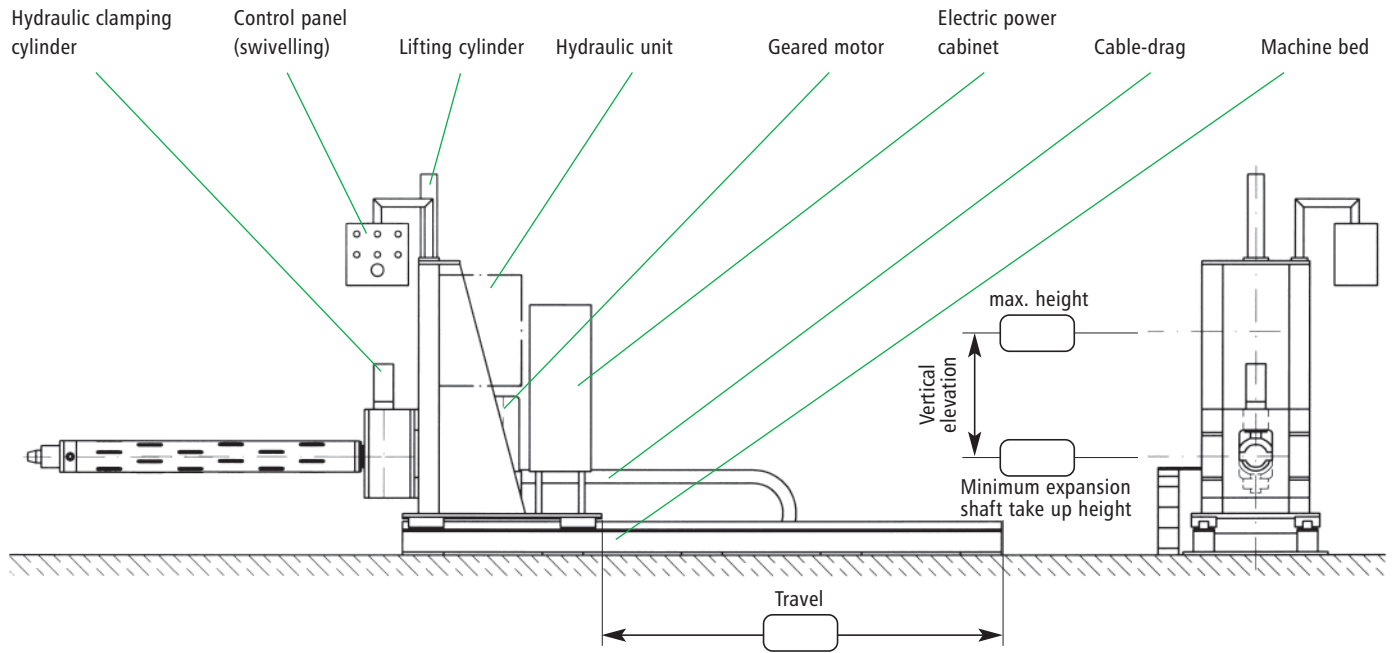

### Version

- Constructional form 1: Travelling Shaft Puller
- Constructional form 2: Stationary Shaft Puller
- Constructional form 3: Special version of Shaft Puller
- Options for Vorwald Shaft Pullers

.....

.....

### Comments

.....

.....

.....

### Technical requirements

- Expansion shaft weight (max.) ..... kg
- Expansion shaft length (max.) ..... mm
- Expansion shaft diameter (max.) ..... mm
- Reel diameter (max.) ..... mm
- Reel weight (max.) ..... kg
- Expansion shaft take up height (min.) ..... mm
- Expansion shaft take up height (max.) ..... mm
- Vertical elevation ..... mm
- Time for reel change ..... min.
- Electric supply voltage ..... V/ ..... Hz
- Control voltage ..... V/DC
- Compressed air supply ..... bar
- Operator control
  - manual
  - semi-automatic
  - fully automated

## Stationary Shaft Puller Constructional form 2

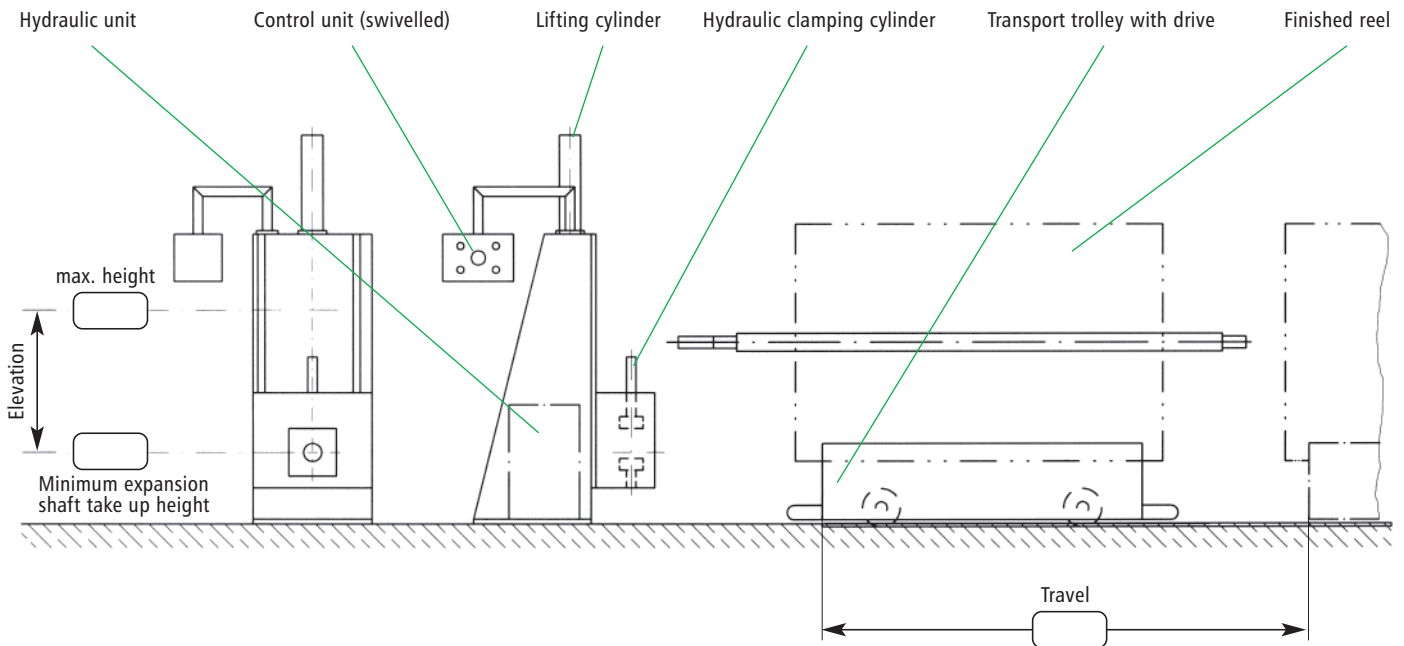

### Version

- Constructional form 1: Travelling Shaft Puller
- Constructional form 2: Stationary Shaft Puller
- Constructional form 3: Special version of Shaft Puller
- Options for Vorwald Shaft Pullers

.....

.....

### Comments

.....

.....

.....

### Technical requirements

- Expansion shaft weight (max.) ..... kg
- Expansion shaft length (max.) ..... mm
- Expansion shaft diameter (max.) ..... mm
- Reel diameter (max.) ..... mm
- Reel weight (max.) ..... kg
- Expansion shaft take up height (min.) ..... mm
- Expansion shaft take up height (max.) ..... mm
- Vertical elevation ..... mm
- Time for reel change ..... min.
- Electric supply voltage ..... V/ ..... Hz
- Control voltage ..... V/DC
- Compressed air supply ..... bar
- Operator control
  - manual
  - semi-automatic
  - fully automated



## Representations in

Austria  
Czech Republic  
Denmark  
Finland  
France

Germany  
Great Britain  
Greece  
Hungary  
Iran

Israel  
Macedonia  
Netherlands  
Norway  
Poland

Portugal  
Slovakian Republic  
Slovenia/Croatia  
South Africa  
Spain

Sweden  
Switzerland  
Turkey  
USA



Production plant in Neuenhaus

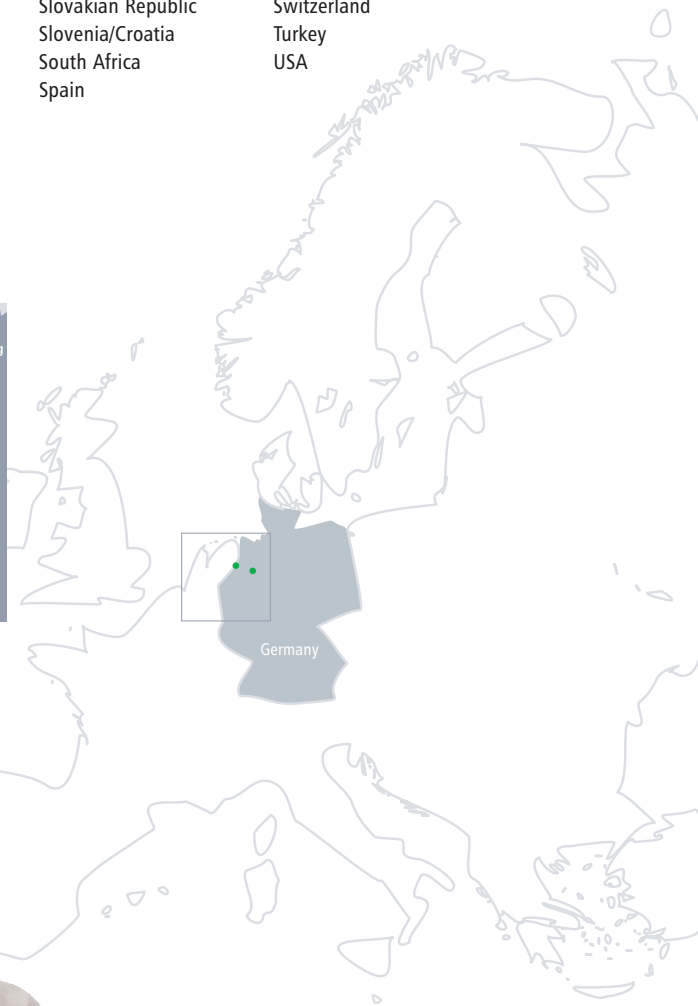

## Neuenhauser Maschinenbau GmbH

### Sales Department

### Vorwald Expansion Units

Iburger Straße 225

D-49082 Osnabrück

Phone +49 (0) 541 / 5 05 46 - 0

Telefax +49 (0) 541 / 5 05 46 - 10

E-Mail [neuenhauser@vorwald.de](mailto:neuenhauser@vorwald.de)

Internet [www.vorwald.de](http://www.vorwald.de)

### Headquarters and service

Hans-Voshaar-Straße 5

D-49828 Neuenhaus

Phone +49 (0) 59 41 / 604-0

Telefax +49 (0) 59 41 / 604-206



## Myynti

|   |   |   |  |
|---|---|---|--|
| Vantaa<br>Pyymosantie 4<br>01720 Vantaa | Turku<br>Polttolaitoksenkatu 5<br>20380 Turku | Tampere<br>Lentokentänkatu 9 C<br>33900 Tampere | Oulu<br>Revontie 2<br>90830 Haukipudas |
|---|---|---|--|

## Huolto ja kokoonpano

|   |   |  |
|---|---|--|
| Vantaa<br>Pyymosantie 4<br>01720 Vantaa | Turku<br>Polttolaitoksenkatu 5<br>20380 Turku | Puh. 010 8345 500<br>power.hydraulics@masino.fi<br>www.masino.fi/masino-konaflex |
|---|---|--|

Masino Group on yritysryhmä, joka tarjoaa voimansiirtoratkaisuja, hydraulikkaa ja suodatus-tekniikkaa, pumppuja, puhaltimia ja teollisuushuoltoa, putkistotuotteita, kiinnitystekniikkaa, hitsaustekniikkaa, juotostekniikkaa, kallionlujitustuotteita, betonikuituja sekä talotekniikan kiinnitys- ja asennustarvikkeita. Liikevaihtomme on noin 65 M€ ja henkilöstön määrä 160. Toimipisteemme sijaitsevat Vantaalla (2), Ylöjärvellä, Tampereella ja Turussa.