

Atlas Copco

Centralized intelligence. Decentralized installation.

DZS VSD⁺ and DZM VSD⁺

Mono and Multi-claw Dry Vacuum pumps
with VSD⁺ technology





DZS 100 – 400 VSD+

The DZS 100 VSD+, DZS 200 VSD+ and DZS 400 VSD+ are a range of Class 0 certified dry claw vacuum pumps; single stage, oil-free, air-cooled and with the VSD+ inverter drive technology built-in. The DZS VSD+ series are a range of long life and durable pumps with very low maintenance for rough vacuum applications. These compact machines with small footprint deliver high reliability through a rugged and robust design.

Superior performance. Designed to fit process needs.

In terms of performance, the DZS VSD+ series helps achieve ultimate vacuum. This is possible thanks to the integrated VSD+ inverter drive and PI-Loop. As a result, the pump is able to operate at its ultimate vacuum level continuously without overheating. Allowing the DZS VSD+ to effortlessly meet a wider range of process demands and vacuum applications.

There is always a better way

This guiding principle has driven Atlas Copco's vacuum engineers and designers to develop new technologies and revolutionize existing ones. Our innovative products and solutions contribute to the productivity of our customers.

Traditionally, our vacuum pumps offer lower lifecycle costs, higher performance, less energy consumption, simple operation and control, and also easy maintenance.

Now, we offer more than just that. Think about intelligence, optimization, plug & play, digitalization, efficiency and innovation. Think about the Atlas Copco DZS VSD+ and DZM VSD+ intelligent dry claw vacuum pumps.



Pre-wired, plug and play pressure sensor



VSD+ drive

Optional connection to temperature sensor

Keypad foil



Centralized intelligence. Decentralized installation.

At Atlas Copco we believe that + is more. The pumps are equipped with a VSD+ drive on the motor, enabling PI-Loop functionality as well as multiple options for remote connectivity, including the in-house developed Atlas Copco VSD+ app. We take a static pump and make it intelligent.

Multiple ways to connect to your DZS VSD+ intelligent pump

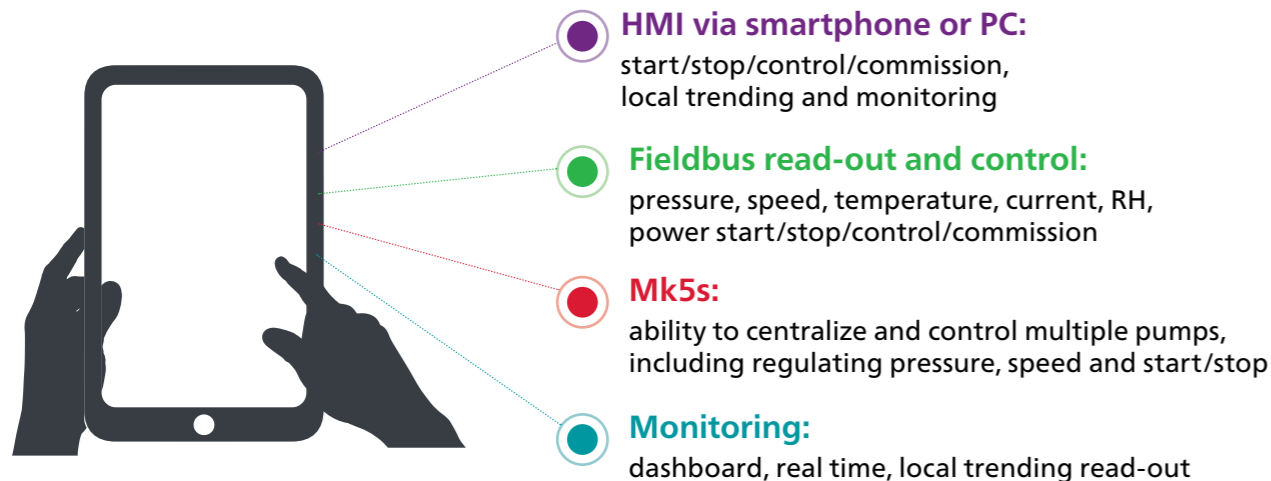

What if a smartphone could control a vacuum pump?

VSD+ * Introducing the VSD+ app, a unique application for iOS and Android devices – an app that lets you control and monitor a vacuum pump with your smartphone. The VSD+ app allows for ease of commission for your DZS VSD+ vacuum pump by only providing 3 parameters – target pressure, start/stop delay and stop level. Start your pump, connect the VSD+ app via bluetooth, enter the desired parameters and you are set to run your pump.

*The VSD+ app is available both on App Store and Google Play



With the VSD+ App you also have live visualization of the actual performance and settings. You can monitor details such as inlet pressure, rotor speed, running hours, service intervals, etc.

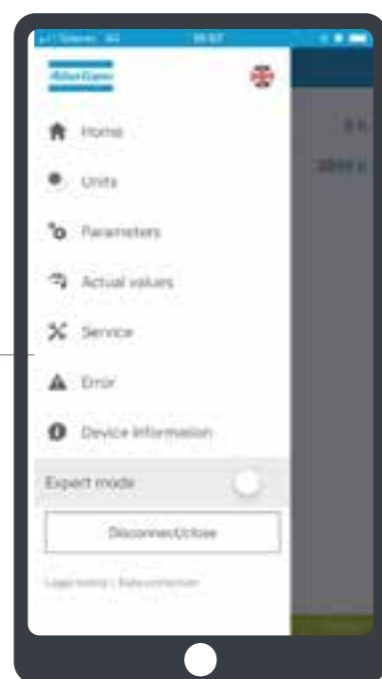

Welcome to the new forefront in vacuum pump control.



Efficient pumps with low lifecycle costs

The new range of DZS VSD+ and DZM VSD+ vacuum pumps build upon Atlas Copco's dry claw technology features and innovative design. The simplicity, robustness, efficiency and contaminant handling capability of these pumps make them the smart choice for your application. Built to the exacting standards that we demand and our customers expect, the new dry claw pump provides you with a trouble-free and cost-effective solution to meet your needs.

Built to last

Manufactured on the fundamentals of Atlas Copco compressor design, these pumps feature some innovative construction materials and coatings for a long life of reliable operation even in harsh conditions.

Cleverly designed element

The separate and isolated element along with the patented cooling concept provide:

- Longer life bearings and seals
- Quick and straightforward access
- Easy cleaning
- Reduced maintenance time

Superior performance

- Extensive product range
- Superior ultimate vacuum level
- Lower power consumption
- Minimal machine lifecycle costs
- Low noise levels

All pumps feature corrosion-resistant stainless steel claws.



A robust and innovative vacuum pump designed for a long life of reliable, efficient operation



Dry (oil-free) pumping chamber



Efficient motor with variable speed option for complete controllability



Simple maintenance with contact-free internals eliminating wear



Cool running and simple air cooling



Compact design with a small footprint



Class 0 certified

The DZS VSD+ pumps are certified as being harmless to the quality of the ambient air during the process, eradicating the risk of oil-induced damage to sensitive applications and products. This certification also provides an assurance of sustainability by eliminating the potential harm to humans and the environment that can arise from the use of oil emitting vacuum pumps.

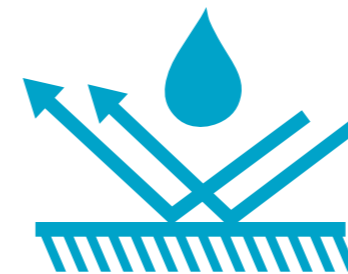

Built-in corrosion resistance

The DZS VSD+ is equipped with corrosion resistant materials to be compatible with even the harshest applications. The DZS VSD+ series comes with stainless steel claws, and a resistive and durable coating applied to the pumping chamber.



Easy and low cost on-site maintenance

The DZS VSD+ is designed for simple and low-cost maintenance. Easily cleanable, removable, and replaceable claws do not require complex gearbox stripping and retiming. This allows for fast inspection and quick access to the pumping chamber makes for easy cleaning in the event of product carry-over.



Option for humid applications available

In addition to the robust build quality that withstands harsh applications, the pump includes an inlet liquid separator and a condensate drain facility especially for humid applications.

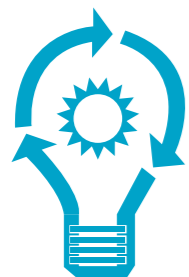

Boosting energy efficiency and performance

With minimal manual intervention, the unique self-sizing features increase efficiency and boost performance. The factory mounted motors are equipped with a VSD+ inverter drive, providing complete controllability and reducing power consumption. This helps to continuously save energy and consequently deliver a lower carbon footprint.

DZM VSD+ multi-claw vacuum system

A complete multi-claw vacuum pumping system in a box. A solution perfectly designed to meet your larger process demands with a central vacuum system based on the renowned Atlas Copco compressor philosophy. This vacuum pumping package offers a completely controllable system ranging from 44 to 1,230 m³/h integrated into one cabinet with a simple plug & play concept.

At the heart of this system is the DZS VSD+ claw pump providing efficiency, robustness and ultimate performance.

With three sizes available, plus the option to expand the central vacuum system with centrally controlled multiple packages, we can offer a complete turn-key solution regardless of your requirements.



Dimensions

Length	1420 mm, 56"
Width	990 mm, 39"
Height	1980 mm, 78"



Low noise

Atlas Copco prides itself on offering environmentally friendly solutions and noise plays a big part. Our reputation for designing and building noise-reducing canopies is renowned in the industry and comes from many years of experience in the world of compressors.

Plug & play

This concept of design greatly reduces complexity and installation costs compared to other central systems designs. The package not only consists of the pumps but also comprises the common inlet manifold and an exhaust manifold resulting in two simple pipe connections.

The control system including the Variable Speed Drive and all necessary process transmitters and safety devices are incorporated in a 'cool zone' adding to its simplicity and reliability.



Complete controllability

Atlas Copco's DZM VSD+ multi-vacuum pump controllers allows the DZM package to start/stop and control multiple vacuum pumps simultaneously according to set working pressures. The controller comes with a built-in frequency inverter for the lead pump and the lag pumps are started with soft starters to lighten the load and lengthen the life of the pump.

Save energy & cut costs

Thanks to smart algorithms, the controller delivers an optimal blend of product performance. It does this by measuring the working pressure and ensuring the collective pumps work together and deliver proportionately.

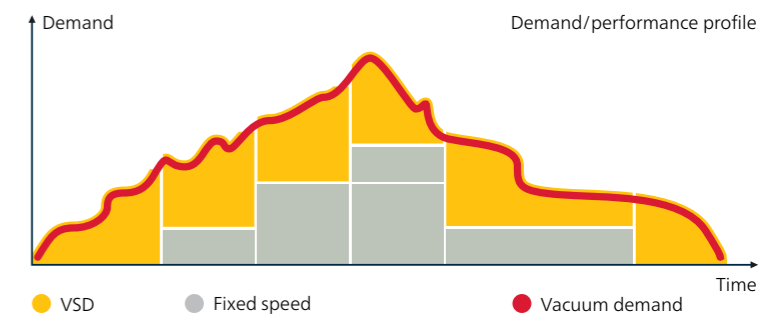

Elektronikon® monitoring system

Elektronikon® is an intelligent monitoring system for your vacuum pumps. It is simple yet comprehensive and leads to energy savings. It can also integrate your plant management system thanks to a remote monitoring option.

Easy to use

- 3.5-inch high-definition color display with clear pictograms, and 32 language settings.
- Additional LED indicator for service.
- Graphical display of key parameters (day, week, month).
- Elektronikon® installed on different vacuum pumps can be monitored in cascade.

Comprehensive

- Monitoring: status, running/stopped hours, programmable timers, set point control and other settings.
- Safety: Elektronikon® provides warning, fault and shutdown indications.
- Service: service operations, remote control (optional).



SMARTLINK: more than just a watchful eye

SMARTLINK is an optional solution for data monitoring: easy to install and customizable. It brings system relevant data to your smartphone, tablet and PC. Whenever you have access to the internet, you obtain the information you need to respond quickly to changing circumstances. Service calls can be efficiently planned and production losses minimized.



Technical specifications

DZS 100 VSD+		
Min pumping speed	m ³ /h/cfm	6/4
Max pumping speed	m ³ /h/cfm	105/62
Ultimate vacuum	mbar/”HgV	50/28.4
Overdrive from 200 mbar abs to atmosphere		
Motor power	kW/hp	3/5

DZS 200 VSD+		
Min pumping speed	m ³ /h/cfm	3/2
Max pumping speed	m ³ /h/cfm	189/111
Ultimate vacuum	mbar/”HgV	50/28.4
Overdrive from 200 mbar abs to atmosphere		
Motor power	kW/hp	5,5/7

DZS 400 VSD+		
Min pumping speed	m ³ /h/cfm	44/26
Max pumping speed	m ³ /h/cfm	398/234
Ultimate vacuum	mbar/”HgV	140/25.4
Overdrive from 200 mbar abs to atmosphere		
Motor power	kW/hp	11/15

Performance

DZS 100 VSD+ specifications

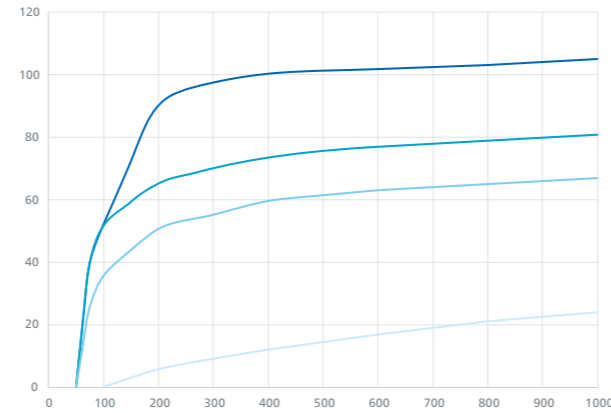

DZS 200 VSD+ specifications

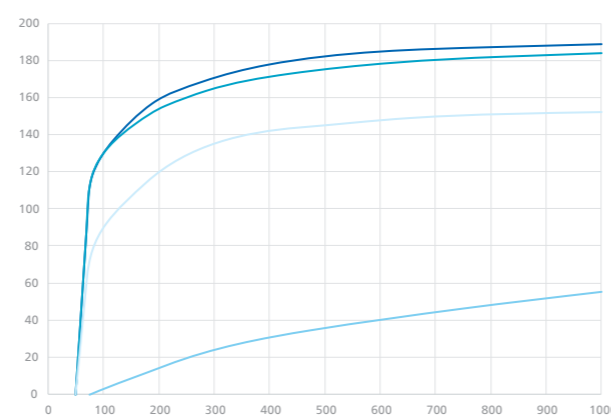

DZS 400 VSD+ specifications

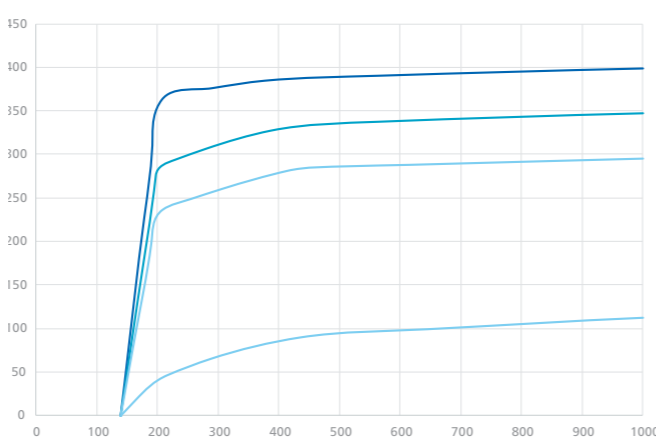

Technical specifications DZM VSD+ multi-claw system

Type	Number of integrated pumps	Nominal displacement		Ultimate vacuum Level			Permissible ambient temperature range		Inlet connection size	Exhaust connection size	Shaft power minimum / maximum	
		m ³ /h @50Hz grid**	cfm @60Hz grid***	mbar	hgV	Torr	°C	°F			Flange	Flange
DZM 600 VSD*	2	604	383	150	25.5	112.5	0 - 40	32 - 105	DN80	DN80	1,5 - 15,9	2,0 - 25,2
DZM 900 VSD*	3	874	569	150	25.5	112.5	0 - 40	32 - 105	DN100	DN100	1,5 - 22,0	2,0 - 37,3
DZM 1200 VSD*	4	1143	755	150	25.5	112.5	0 - 40	32 - 105	DN100	DN100	1,5 - 28,4	2,0 - 49,7

*US 60Hz Versions supplied with ANSI adaptor flanges.
 Figures based on 50Hz operation, 400 V.
 **Figures based on lead pump with 20 to 60Hz operation, subsequent pumps operating at 50Hz, 400 V.
 ***Figures based on lead pump with 20 to 60Hz operation, subsequent pumps operating at 60Hz.
 Pumping speed based on air at 20°C. Tolerance +/-10%.
 Shaft power based on one pump at minimum speed 1200rpm and maximum power achieved when lead pump is at 60Hz operation and lag pumps at 50Hz.

Drawings and Dimensions

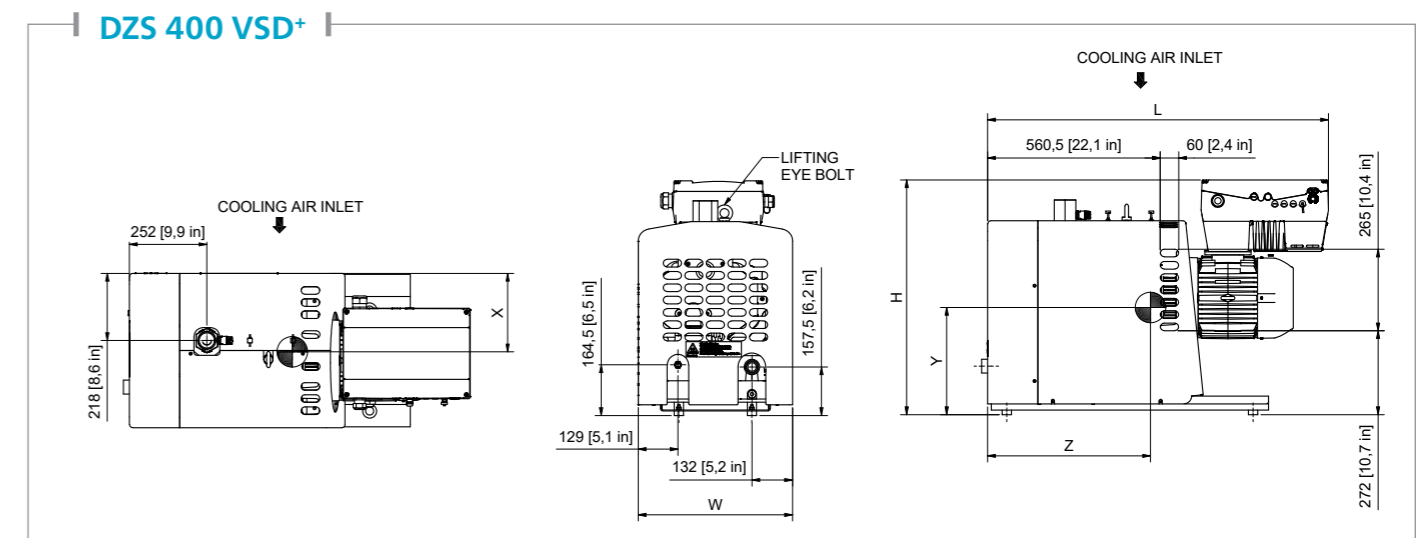
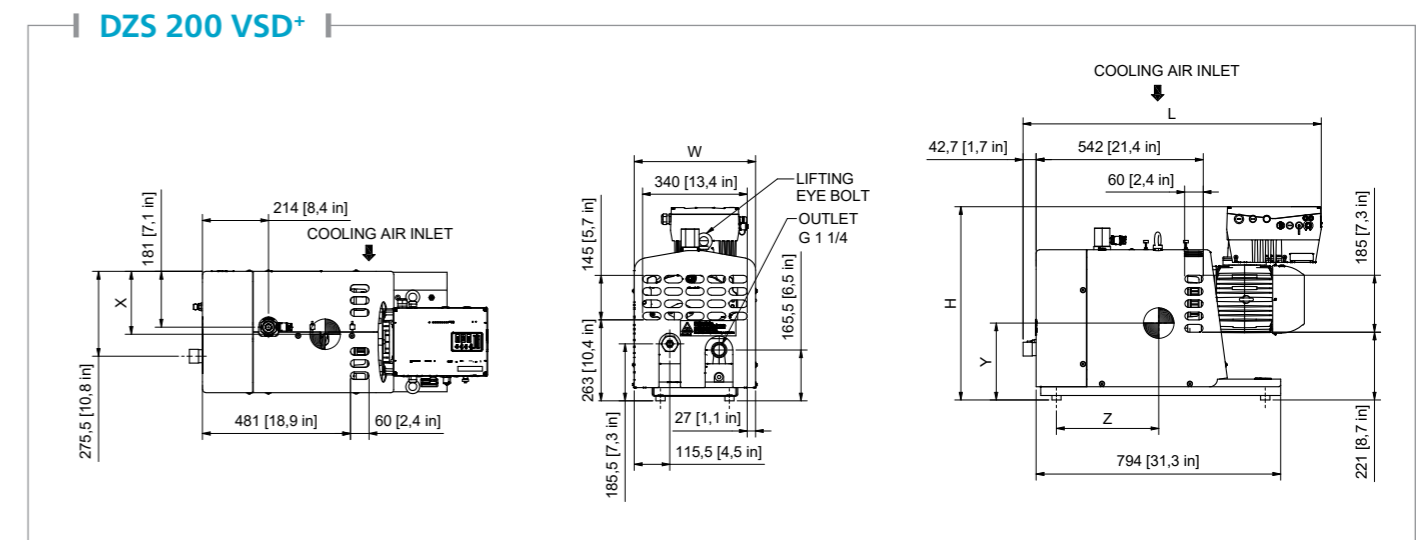
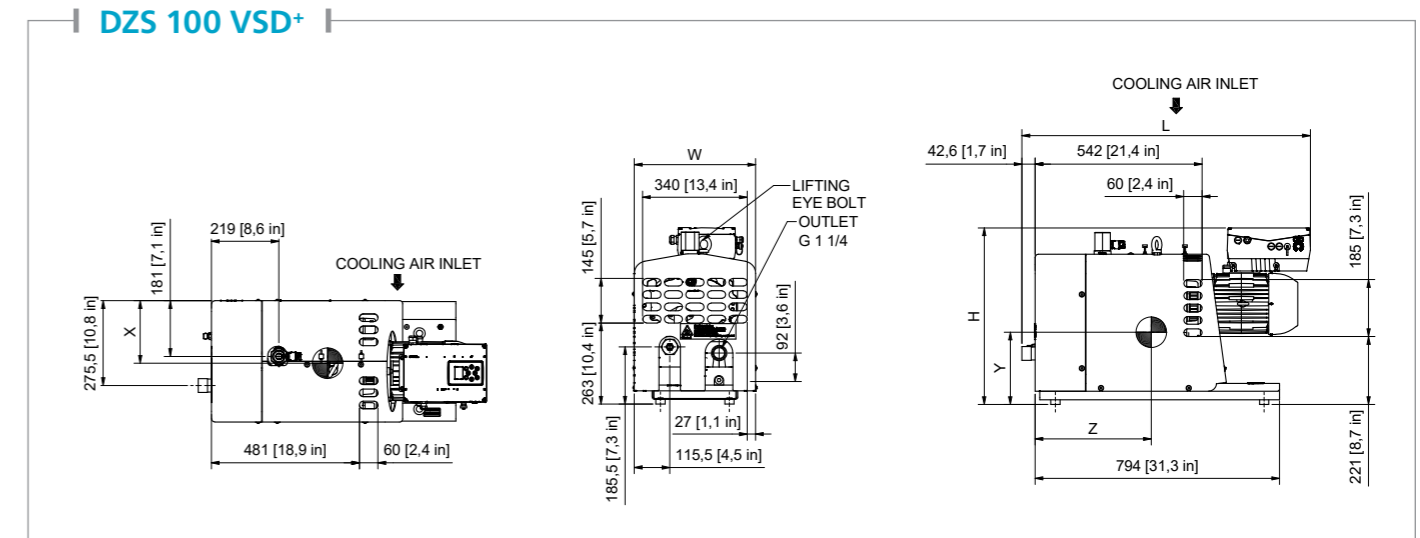



atlascopco.com

